

FYL- 5019URUGW1B- 001

Features:

- High intensity
- General purpose leads
- RoHs complant.

Descriptions:

- Dice material R: GaAsP
G: AlGaInP
- Emitting Color R: Super bright Orange
G: Super bright Green
- Device Outline: $\Phi 5\text{mm}$ Round Type.
- Lens Type: White diffused.

Radiation pattern.

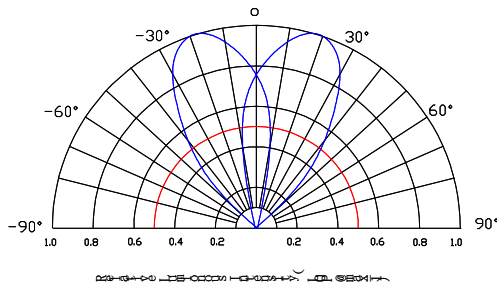

Package configuration

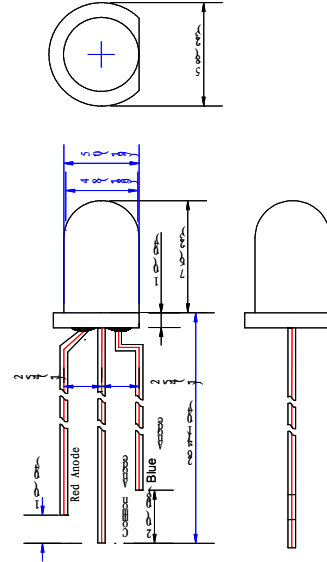

- ◆ All dimensions are millimeters (inches)
- ◆ Tolerance is $\pm 0.25\text{mm}(.010\text{'})$ unless otherwise noted.

Absolute maximum ratings($T_a=25^\circ\text{C}$)

Parameter	MAX.		Unit
Power Dissipation	R	50	mW
	G	50	
Peak Forward Current (1/10 Duty Cycle, 0.1ms Pulse Width)	100		mA
Continuous Forward Current	20		mA
Derating Linear From 50°C	0.4		mA/ $^\circ\text{C}$
Reverse Voltage	5		V
Operating Temperature Range	-30°C to $+80^\circ\text{C}$		
Storage Temperature Range	-40°C to $+100^\circ\text{C}$		
Lead Soldering Temperature[4mm(.157") From Body]	260 $^\circ\text{C}$ for 5 Seconds		

Electrical and optical characteristics(Ta=25 °c)

Parameter	Symbol	Min.	Typ.	Max.	Unit	Test Condition
Luminous Intensity	I _v	E	-	300	-	mcd
		G	-	360	-	
Viewing Angle	2θ _{1/2}	E	45	50	55	Deg
		G	45	50	55	
Peak Emission Wavelength	λ _p	E	635	640	645	nm
		G	563	568	573	
Dominant Wavelength	λ _d	E	632	637	642	nm
		G	567	572	577	
Spectral Line Half-Width	Δλ	E	10	15	20	nm
		G	15	20	25	
Forward Voltage	V _F	E	1.6	2.0	2.4	V
		G	1.8	2.3	2.8	
Reverse Current	I _R		-	50	uA	V _R =5V

Typical Electrical Characteristics Curves (25 °c Ambient Temperature Unless Otherwise Noted)

Spectral Reduance

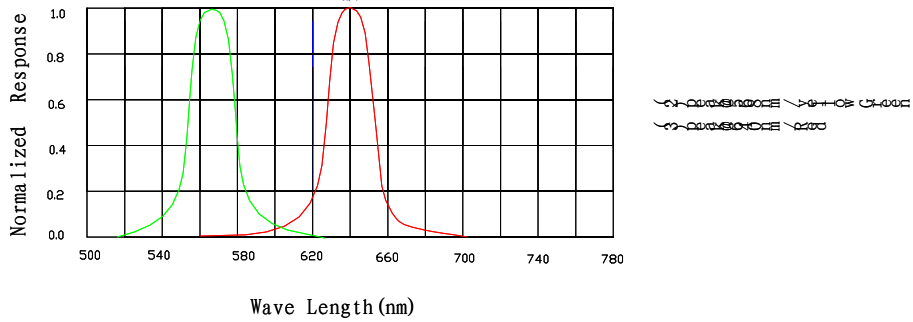

Forward Current Vs Forward Voltage

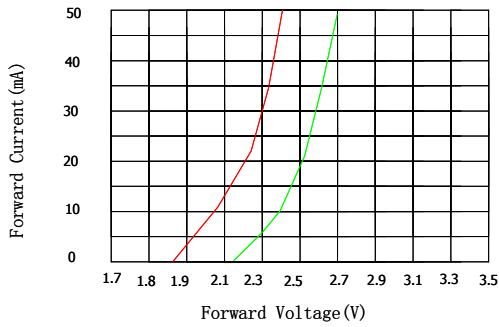

Relative Luminous Intensity vs Forward Current

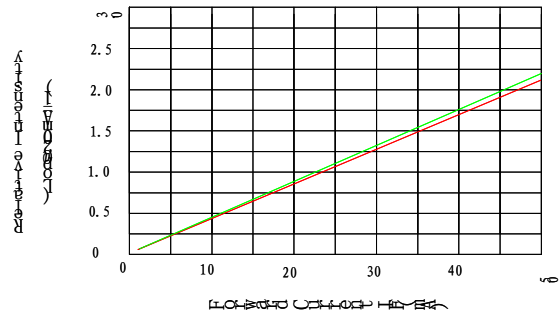

Forward Current Derating Curve

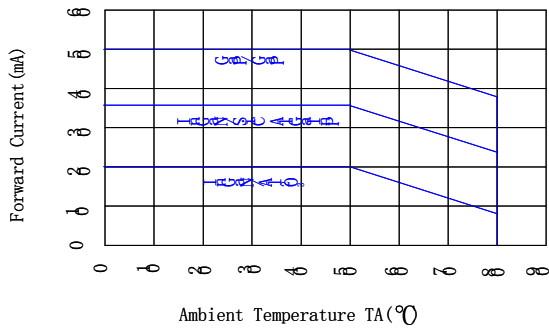

Relative Luminous Intensity vs Ambient Temperature

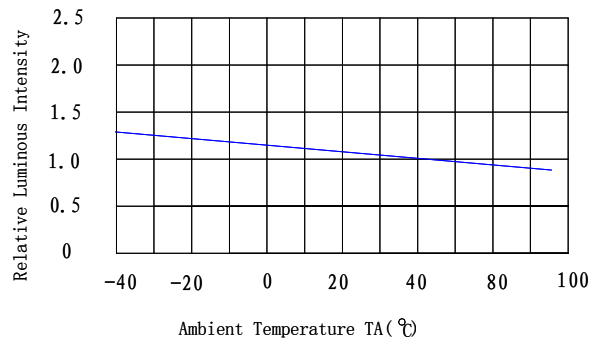

LAMP PACKING.

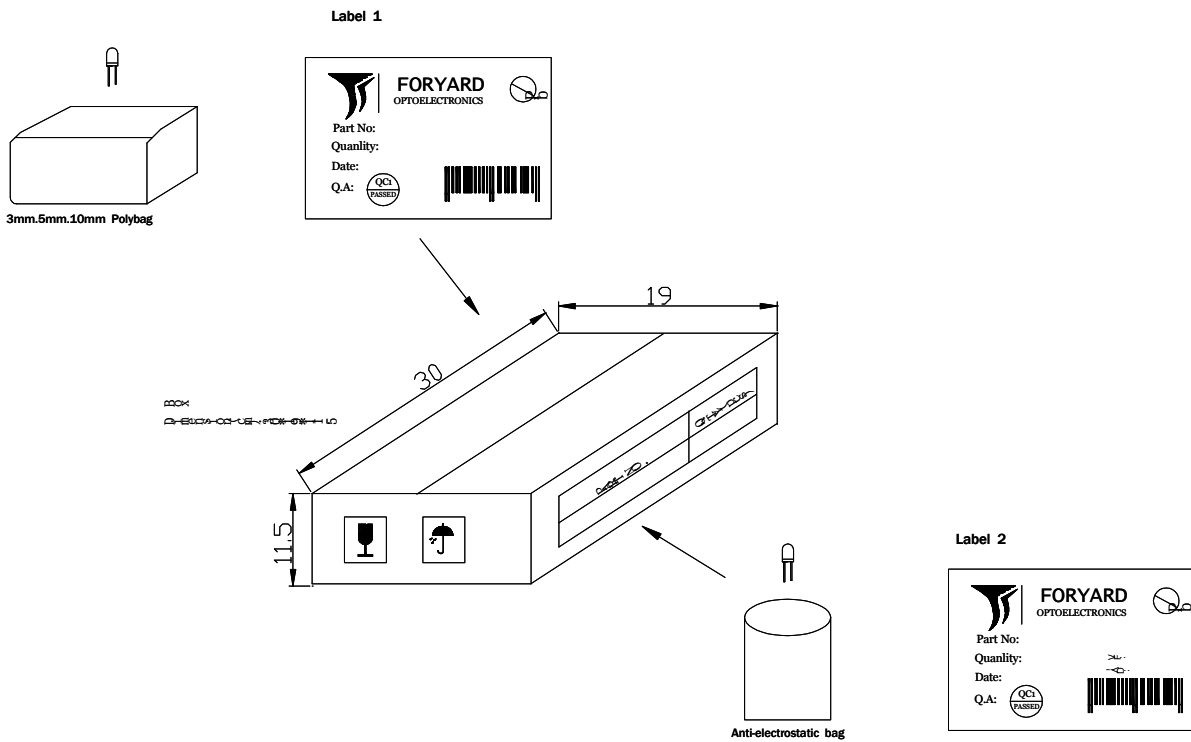

DEVICE	QTY/polybag (pcs)	Polybag/box A	Fig
5mm(T-1 3/4)	1000	8 bags	Label 1
3mm(T-1)	1000	10 bags	Label 1
10mm(T-1)	250	8 bags	Label 1
Blue/Green/White	500pcs	8 bags	Label 2

Dimension(cm): 38*31*38

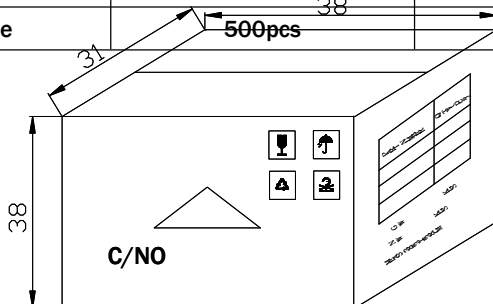

6 Boxes/Carton
 5mm:48,000pcs
 3mm:60,000pcs
 10mm:12,000pcs
 Blue/Pure Green/bluish Green
 /White:24,000pcs



LED LAMP