

2T32X2RX0003HSAA

Ultra high reliability and luminous efficacy ,PLCC LED Series are optimized to be used as lighting for automotive signal lighting designs or signboard.

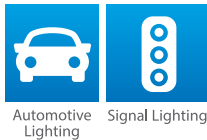

Applications :

- Automotive Interior/Exterior Lighting
- Signal Lighting
- Traffic Lighting

Features :

- Package: Ag Plated 3 pad design package with silicone resin
- Dimension: 4.0 mmx4.3 mmx2.75 mm
- Chip technology: AlGaInP
- View Angle: 120°
- Color: $\lambda_{dom}=616nm$ (Red)
- ESD: 2 kV acc. to ANSI/ESDA/JEDEC JS-001 (HBM, Class 2)
- MSL: Level 2
- Qualifications: The product qualification test based on the guidelines of AEC-Q102



Table of Contents

General Information	3
Absolute Maximum Ratings	4
Characteristics	4
Luminous Intensity Characteristic.....	5
Voltage Bin Structure	5
Wavelength Bin Structure	5
Characteristic Curves	6
Mechanical Dimensions.....	10
Reflow Profile	11
Cautions.....	12
Revision History	13
About Edison Opto	13

General Information

Ordering Code Format

2 T 32 X2 RX 00 03 H S A A
 X1 X2 X3-X4 X5-X6 X7-X8 X9-X10 X11-X12 X13 X14 X15 X16

X1	X2		X3-X4		X5-X6		X7-X8	
Type	Component		Series		Wattage		Color/CCT	
2	Emitter	T	PLCC	32	4043 Sided	X2	0.2W	RX Red

X9-X10		X11-X12		X13		X14		X15	
CRI(Ra)		Voltage		Leadframe Mode		Leadframe Plating		Model	
00	Single Color	03	3V	H	PPA Sided 2.75H 3Pin	S	Silver	A	Automotive

X16
Serial Number

Absolute Maximum Ratings

Absolute maximum ratings

Parameter		Symbol	Values
Operating Temperature	min.	T_{op}	-40 °C
	max.		110 °C
Storage Temperature	min.	T_{stg}	-40 °C
	max.		110 °C
Junction Temperature	max.	T_j	125 °C
Forward current $T_j = 25\text{ °C}$	min.	I_F	5 mA
	max.		70 mA
Surge Current $t \leq 10\ \mu\text{s}; D = 0.005; T_j = 25\text{ °C}$	max.	I_{FS}	100 mA
Reverse voltage $T_j = 25\text{ °C}$	max.	V_R	10 V
ESD withstand voltage acc. to ANSI/ESDA/JEDEC JS-001 (HBM, Class 2)		V_{ESD}	2 kV

Notes: Proper current derating must be observed to maintain junction temperature below the maximum at all time.

Characteristics

$I_F = 50\text{ mA}; T_j = 25\text{ °C}$

Parameter		Symbol	Values
Peak Wavelength	typ.	λ_{Peak}	625 nm
Dominant Wavelength	min.	λ_{dom}	612 nm
	typ.		616 nm
	max.		624 nm
Viewing angle	typ.	φ	120 °
Forward Voltage	min.	V_F	2.05 V
	typ.		2.25 V
	max.		2.50 V
Reverse current $V_R = 10\text{ V}$	typ.	I_R	0.01 μA
	max.		10 μA
Real thermal resistance junction/solder point	typ.	$R_{thJS\ real}$	60 K / W
	max.		73 K / W
Electrical thermal resistance junction/ solder point with efficiency $\eta_e = 32\%$	typ.	$R_{thJS\ elec.}$	41 K / W
	max.		50 K / W

Luminous Intensity Characteristic

Luminous Intensity Characteristics, $I_f=50\text{mA}$, $T_j=25^\circ\text{C}$

Symbol	Group	Min. Luminous Intensity(mcd)	Max. Luminous Intensity(mcd)	Typ. Luminous Flux(mlm)
Iv	BB	2240	2800	7875
	CA	2800	3550	9922
	CB	3550	4500	10341

Note:

The luminous intensity performance is guaranteed within published operating conditions. Edison Opto maintains a tolerance of $\pm 10\%$ on intensity measurements.

Voltage Bin Structure

Voltage Bin Structure, $I_f=50\text{mA}$, $T_j=25^\circ\text{C}$

Symbol	Group	Min. Voltage (V)	Max. Voltage (V)
V_F	B05	2.05	2.20
	B20	2.20	2.35
	B35	2.35	2.50

Note:

Forward voltage measurement allowance is $\pm 0.1\text{V}$.

Wavelength Bin Structure

Wavelength Bin Structure, $I_f=50\text{mA}$, $T_j=25^\circ\text{C}$

Symbol	Group	Min. Wd (nm)	Max. Wd (nm)
λ_{dom}	R12	612	616
	R16	616	620
	R20	620	624

Note:

Dominant wavelength measurement allowance is $\pm 1\text{nm}$.

Characteristic Curves

Color Spectrum

$I_f = 50 \text{ mA}$; $T_j = 25 \text{ }^\circ\text{C}$

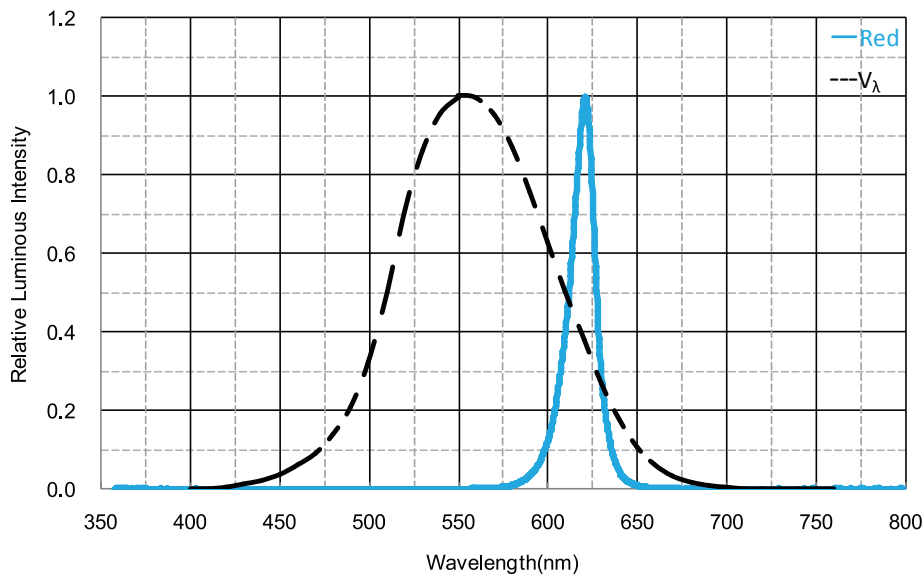

Beam Pattern

$I_f = 50 \text{ mA}$; $T_j = 25 \text{ }^\circ\text{C}$

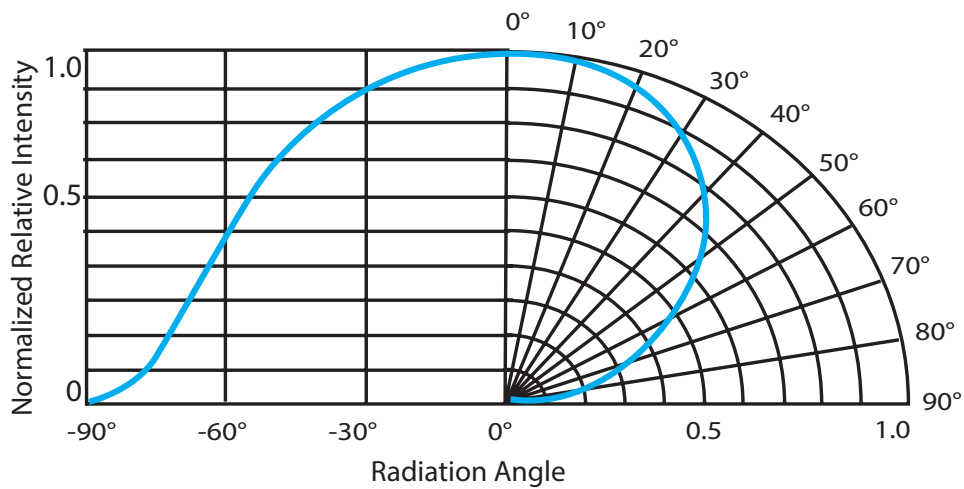

Relative Forward Voltage

$$V_F/V_F(50 \text{ mA}) = f(I_F); T_J = 25^\circ\text{C}$$

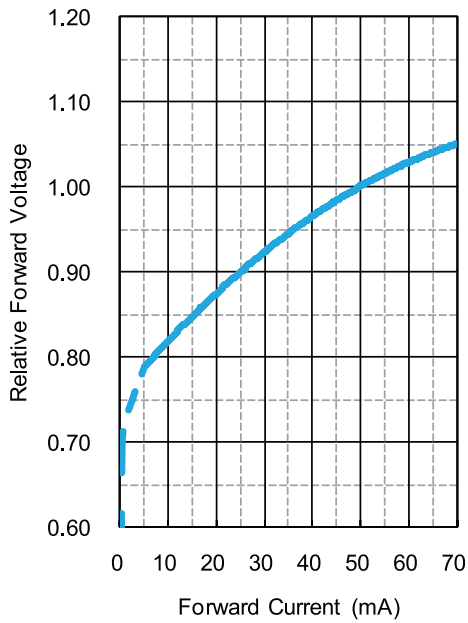

Relative Luminous Intensity

$$I_V/I_V(50 \text{ mA}) = f(I_F); T_J = 25^\circ\text{C}$$

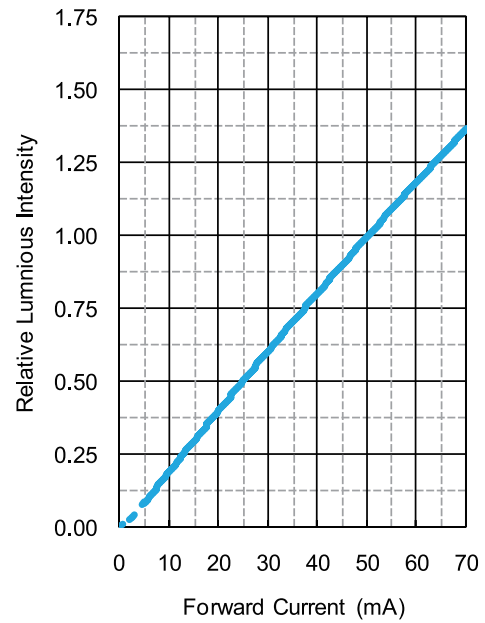

Shift in Dominant Wavelength

$$\Delta\lambda_{\text{dom}} = \lambda_{\text{dom}} - \lambda_{\text{dom}}(50 \text{ mA}); T_J = 25^\circ\text{C}$$

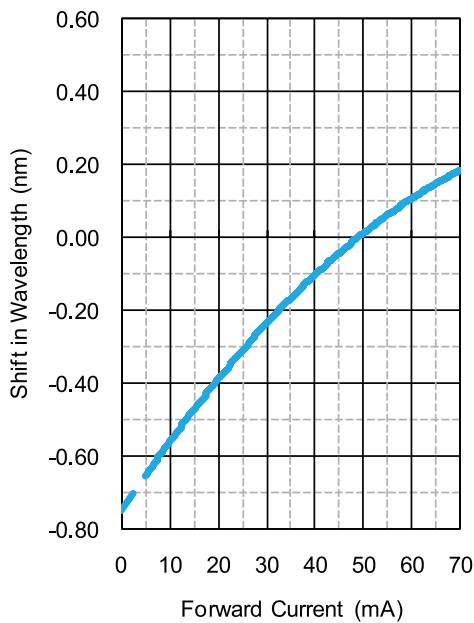

Relative Forward Voltage

$$V_F/V_F(25\text{ }^\circ\text{C}) = f(T_J); I_F = 50\text{ mA}$$

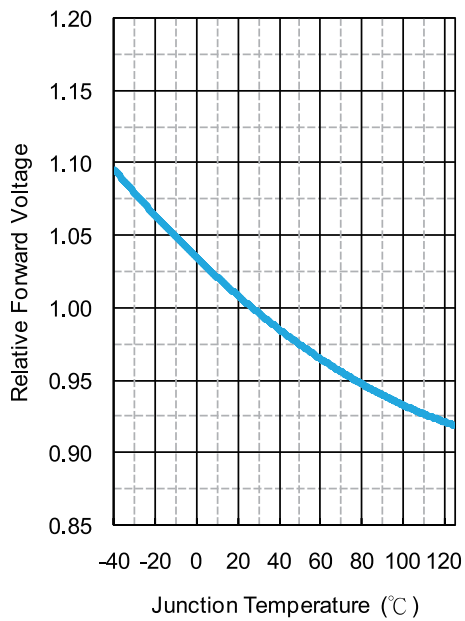

Relative Luminous Intensity

$$I_V/I_V(25\text{ }^\circ\text{C}) = f(T_J); I_F = 50\text{ mA}$$

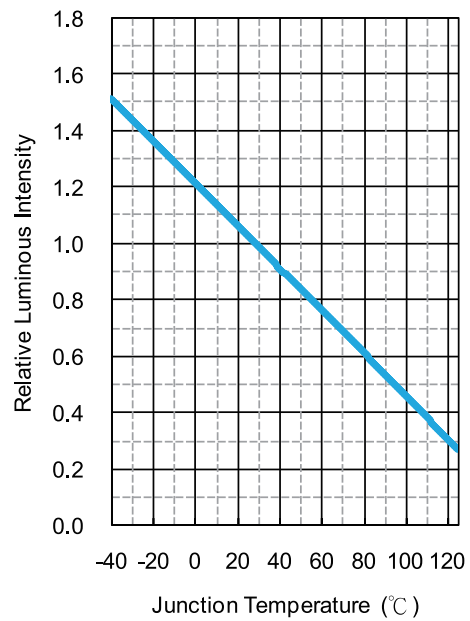

Shift in Dominant Wavelength

$$\Delta\lambda_{\text{dom}} = \lambda_{\text{dom}} - \lambda_{\text{dom}}(25\text{ }^\circ\text{C}); I_F = 50\text{ mA}$$

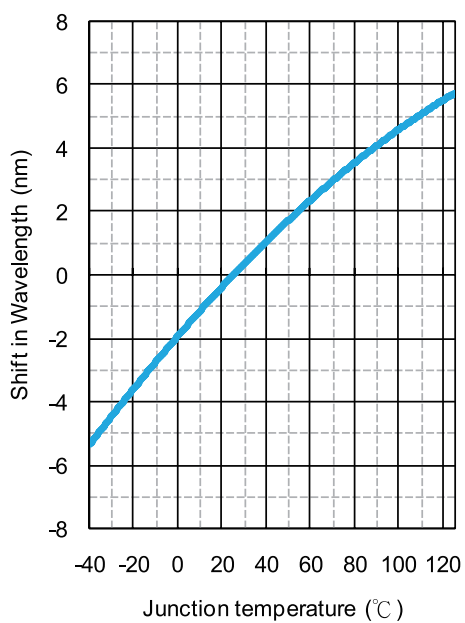

Max. Permissible Forward Current

$$I_f = f(T)$$

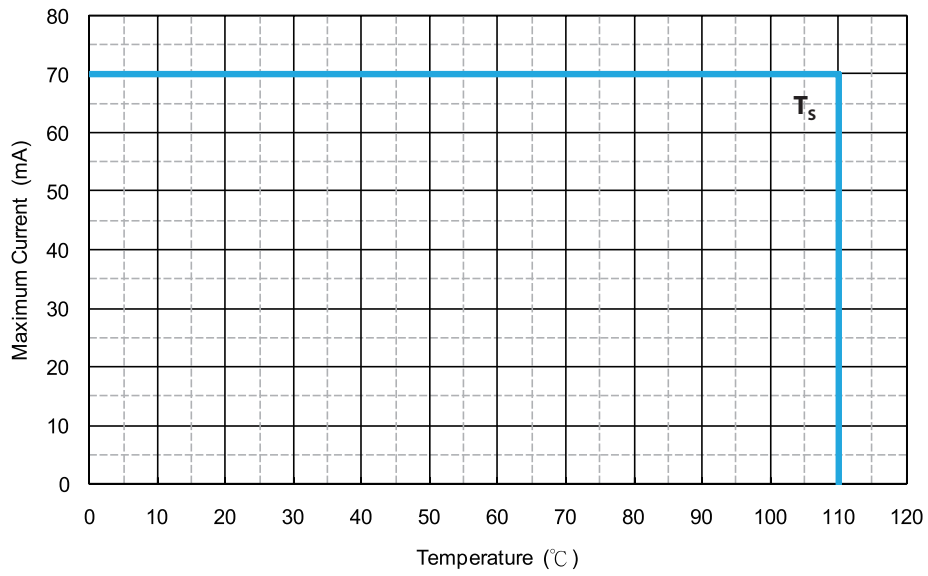

Mechanical Dimensions

Dimensional Drawing

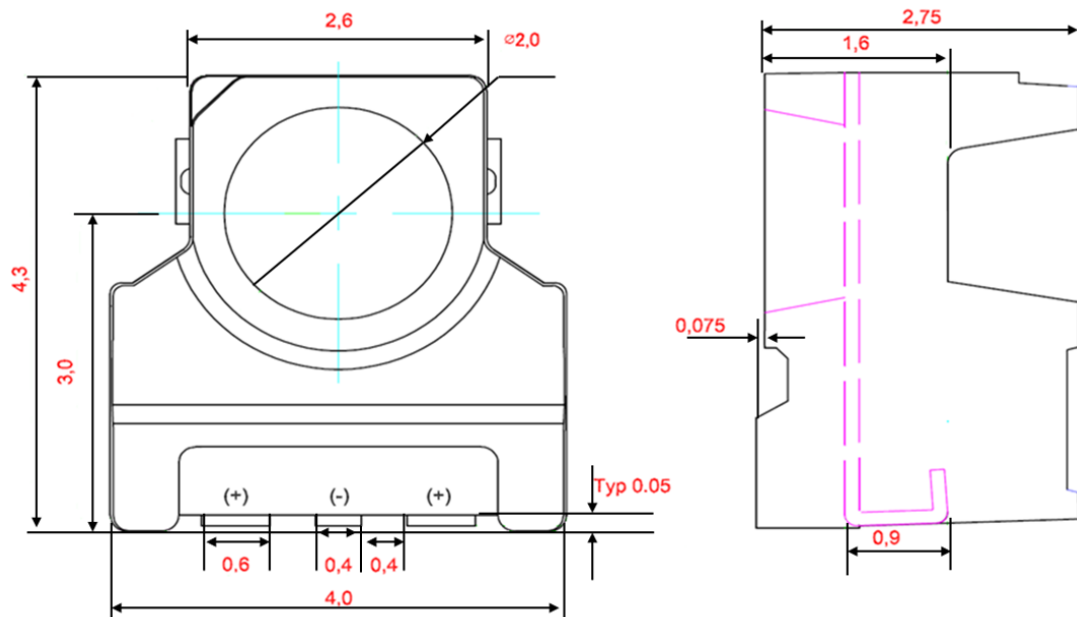

Circuit

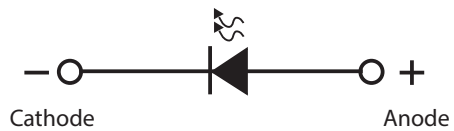

Notes:

1. All dimensions are measured in mm.
2. Tolerance : ± 0.1 mm
3. Approximate Weight : 47.0 mg

Reflow Profile

The following reflow profile is from IPC/JEDEC J-STD-020D which provided here for reference.

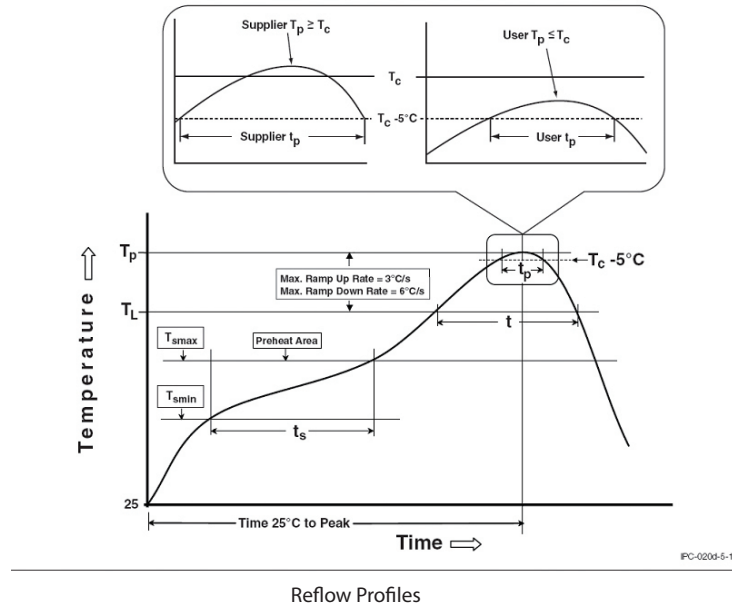

Classification Reflow Profiles

Profile Feature	Pb-Free Assembly
Preheat & Soak Temperature min (T_{smin}) Temperature max (T_{smax}) Time (T_{smin} to T_{smax}) (t_s)	150 °C 200 °C 60-120 seconds
Average ramp-up rate (T_{smax} to T_p)	3 °C/second max.
Liquidous temperature (T_L) Time at liquidous (t_L)	217 °C 60-150 seconds
Peak package body temperature (T_p)	255 °C ~260 °C
Classification temperature (T_c)	260 °C
Time (t_p) within 5 °C of the specified classification temperature (T_c)	30 seconds
Average ramp-down rate (T_p to T_{smax})	6°C/second max.
Time 25°C to peak temperature	8 minutes max.

Cautions

(1) Moisture monitoring is vital during the storage of LEDs for if too much moisture is absorbed, interface delamination and optical performance degradation will occur. Therefore, products should be packed in moisture-proof aluminum bags so as to reduce moisture absorption to the lowest degree during transportation and storage. Included moisture-proof aluminum bag are the key indicators that they will change from brown to azure if bags are invaded by moisture.

(2) Soldering process in compliance with the range of the conditions stated above should be conducted after opening the moisture-proof aluminum bag. The rest LEDs should be stored in a hermetically sealed container, silica gel desiccants included. And the original moisture-proof aluminum bags are recommended.

(3) If the "Period After Opening" storage time is too long or silica gel desiccants don't maintain blue any more, baking process should be done once.

Revision History

Versions	Description	Release Date
0.1	Preliminary	2023/07/03

About Edison Opto

Edison Opto is a leading manufacturer of high power LED and a solution provider experienced in LDMS. LDMS is an integrated program derived from the four essential technologies in LED lighting applications- Thermal Management, Electrical Scheme, Mechanical Refinement, Optical Optimization, to provide customer with various LED components and modules. More Information about the company and our products can be found at www.edison-opto.com

Copyright©2023 Edison Opto. All rights reserved. No part of publication may be reproduced or transmitted in any form or by any means, electronic or mechanical, including photo copy, recording or any other information storage and retrieval system, without prior permission in writing from the publisher. The information in this publication are subject to change without notice.

www.edison-opto.com

For general assistance please contact:
service@edison-opto.com.tw

For technical assistance please contact:
LED.Detective@edison-opto.com.tw