

IEI iDP Introduction

iDP (IEI Internal DisplayPort)

The iDP connector is provided on the IEI products. Through the IEI iDP converter cards, the iDP connector can support different display specifications, such as VGA, HDMI, DVI-D and LVDS.

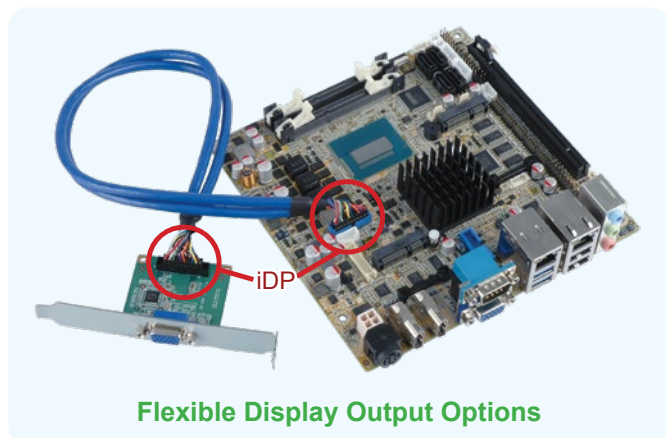

Flexible Display Output Options

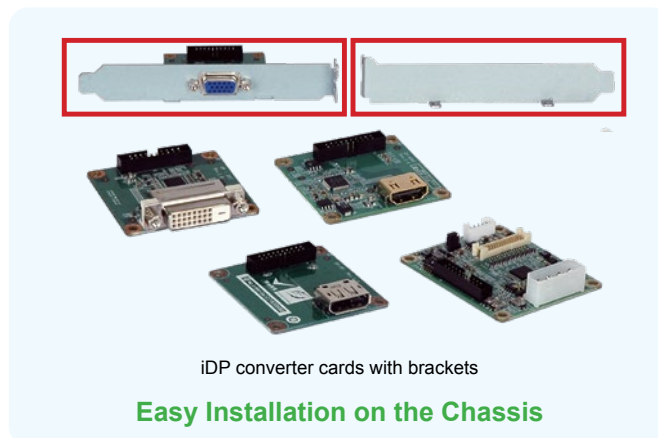

iDP converter cards with brackets

Easy Installation on the Chassis

iDP Supported Models

HPCIE-C236	IMBA-Q170-i2	KINO-DH110	WAFER-AL
HPCIE-Q710	IMBA-H110	KINO-AQ170	WAFER-ULT3/ULT4
SPCIE-C236	IMBA-Q870-i2	KINO-DH810	WAFER-BTW2
PCIE-Q170	IMBA-C2260-i2	KINO-DQM871-i1	WAFER-BT-i1
SPCIE-C2260-i2	IMB-H110	KINO-ABT-i2	WAFER-ULT/ULT2-i1
PCIE-Q870-i2	IMB-Q870-i2	NANO-AL/ALW2	WAFER-KBN-i1
IMBA-C2360-i2	IMB-H810-i2	NANO-ULT3	

DP-DP-R10

DisplayPort Expansion Board (for IEI iDP Connector), RoHS



Features

- DisplayPort to DisplayPort output
- Resolution support up to 1920x1200

Specifications

- ◆ Display Input: 1 x IEI iDP connector
- ◆ Display Output: 1 x DisplayPort
- ◆ Temperature: -20°C ~ 60°C
- ◆ Humidity: 5 ~ 95% non-condensing
- ◆ Dimensions: 50 mm x 50 mm

Dimensions (mm)

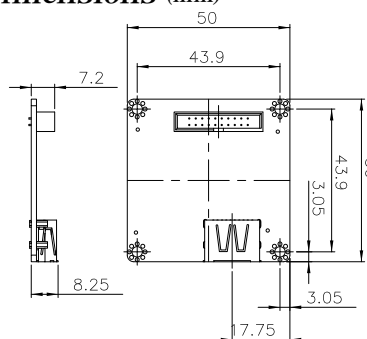

Ordering Information

Part No.	Description
DP-DP-R10	DisplayPort expansion board (for IEI iDP connector), RoHS
32034-000900-100-RS	Round cable, displayport cable, 2, 450mm, 28AWG, (A) USB 3.2 20P P=2.0*2, lites, RoHS

Packing List

1 x DP-DP expansion board	1 x QIG
1 x IEI iDP connector cable, 450 mm length	

DP-HDMI-R10

DisplayPort to HDMI 1.3a Converter Board (for IEI iDP connector), RoHS

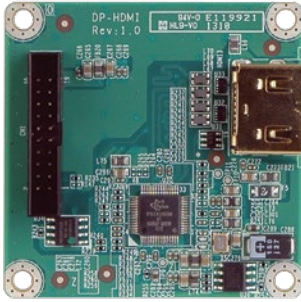

Features

- DisplayPort to HDMI 1.3a output
- Support up to 1920x1200 resolution

Specifications

- ◆ Display Input: IEI iDP connector
- ◆ Display Output: 1 x HDMI 1.3a
- ◆ Display IC: Parade - PS161 (DP to HDMI 1.3a)
- ◆ Temperature: -10°C ~ 60°C
- ◆ Humidity: 5 ~ 95% non-condensing
- ◆ Dimensions: 50 mm x 50 mm

Dimensions (mm)

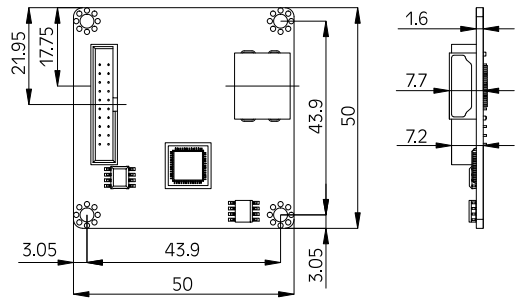

Packing List

1 x DP-HDMI converter board	1 x QIG
1 x Internal DisplayPort cable, 450 mm length	

Ordering Information

Part No.	Description
DP-HDMI-R10	DisplayPort to HDMI 1.3a converter board (for IEI iDP connector), RoHS

DP-LVDS-R10

DisplayPort to 24-bit Dual-channel LVDS Converter Board (for IEI iDP Connector), RoHS

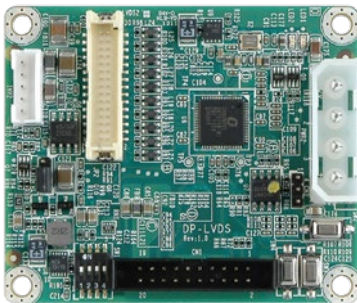

Features

- DisplayPort to LVDS output
- Supports 24-bit dual-channel up to 1920x1200

Specifications

- ◆ Display Input: 1 x IEI iDP connector
- ◆ Display Output: 1 x LVDS 24-bit dual-channel
- ◆ Display IC: Chrontel - CH7511B (DP to LVDS)
- ◆ Temperature: -10°C ~ 60°C
- ◆ Humidity: 5% ~ 95 non-condensing
- ◆ Dimensions: 60 mm x 50 mm

Dimensions (mm)

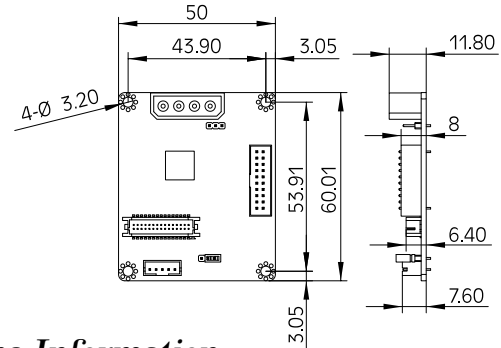

Packing List

1 x DP-LVDS converter board	1 x QIG
1 x Internal DisplayPort cable, 450 mm length	

Ordering Information

Part No.	Description
DP-LVDS-R10	DisplayPort to 24-bit dual-channel LVDS converter board (for IEI iDP connector), RoHS

DP-VGA-R10

DisplayPort to VGA Converter Board (for IEI iDP Connector), RoHS

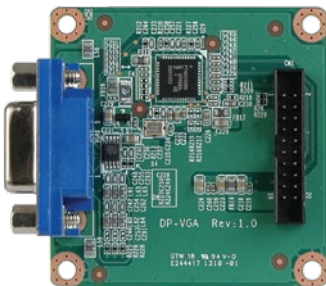

Features

- DisplayPort to VGA output
- Support up to 1920x1200 resolution

Specifications

- ◆ Display Input: 1 x IEI iDP connector
- ◆ Display Output: 1 x VGA
- ◆ Display IC: NXP - PTN3392 (DP to VGA)
- ◆ Temperature: -10°C ~ 60°C
- ◆ Humidity: 5% ~ 95 non-condensing
- ◆ Dimensions: 50 mm x 50 mm

Dimensions (mm)

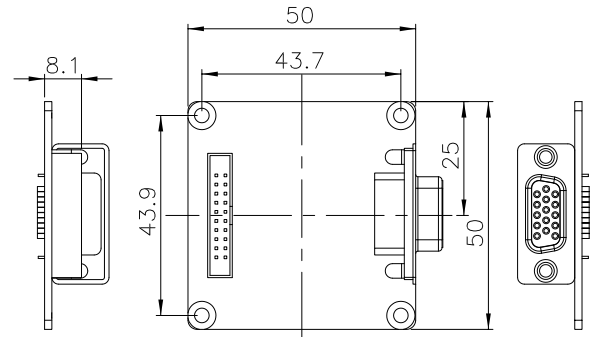

Packing List

1 x DP-VGA converter board	1 x QIG
1 x Internal DisplayPort cable, 450 mm length	

Ordering Information

Part No.	Description
DP-VGA-R10	DisplayPort to VGA converter board (for IEI iDP connector), RoHS

DP-DVI-R10

DisplayPort to DVI Converter Board (for I/EI iDP Connector), RoHS

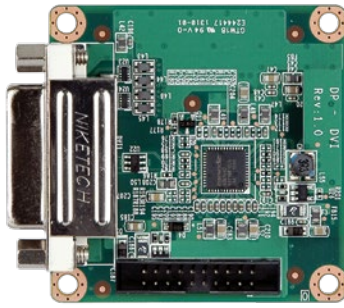

Features

- DisplayPort to DVI output
- Support up to 1920x1200 resolution

Specifications

- ◆ Display Input: 1 x I/EI iDP connector
- ◆ Display Output: 1 x DVI
- ◆ Display IC: Parade - PS161 (DP to HDMI / DVI)
- ◆ Temperature: -10°C ~ 60°C
- ◆ Humidity: 5% ~ 95 non-condensing
- ◆ Dimensions: 50 mm x 50 mm

Dimensions (mm)

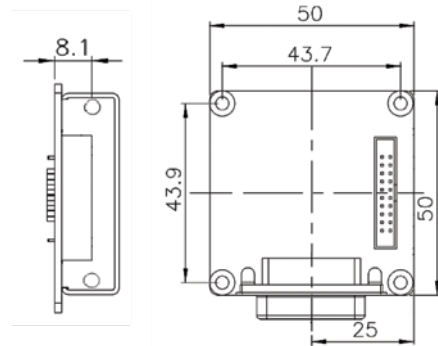

Packing List

1 x DP-DVI converter board	1 x QIG
1 x Internal DisplayPort cable, 450 mm length	

Ordering Information

Part No.	Description
DP-DVI-R10	DisplayPort to DVI converter board (for I/EI iDP connector), RoHS

LVDS-VGA-R10

Single-channel LVDS to VGA Converter Board (Support I/EI Model Only)

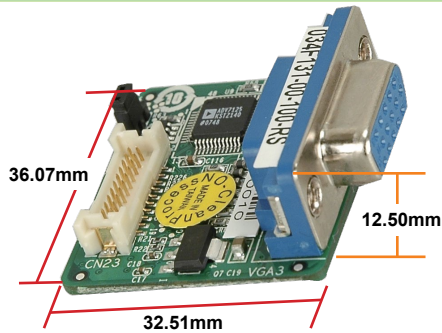

Features

- Provide 2nd VGA option for dual VGA display
- Resolution adjusted by BIOS: Support 1024x768, 800x600, 640x480
- 18-bit LVDS to VGA converter board

Packing List

1 x LVDS to VGA converter board
1 x QIG

Dimensions (mm)

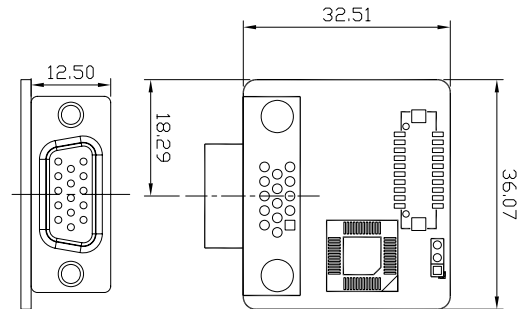

Ordering Information

Part No.	Description
LVDS-VGA-R10	18-bit LVDS to VGA converter board
32600-112300-RS	30-pin LVDS connecting cable
32602-026400-100-RS	20-pin LVDS connecting cable

LVDS24-01

18-bit to 24-bit LVDS Converter Board

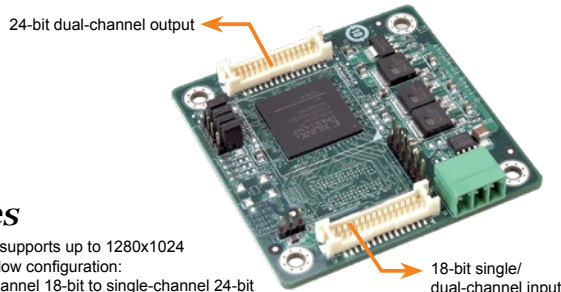

Features

- Resolution supports up to 1280x1024
- Support below configuration:
 - » Single-channel 18-bit to single-channel 24-bit
 - » Single-channel 18-bit to dual-channel 24-bit
 - » Dual-channel 18-bit to dual-channel 24-bit
- * Note: The module does not support dual-channel 18-bit to single-channel 24-bit conversion.

Packing List

1 x 18-bit to 24-bit LVDS converter board
1 x Power cable
1 x QIG



Dimensions (mm)

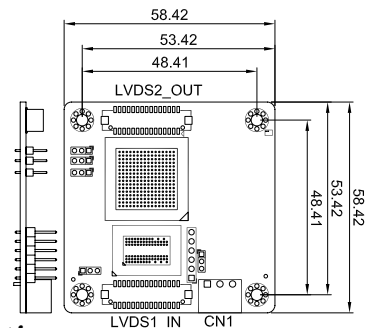

Ordering Information

Part No.	Description
LVDS24-01-R10	18-bit to 24-bit LVDS converter board
32602-007900-100-RS	Single-channel 18-bit 20-pin to 24-bit 30-pin LVDS connection cable
32602-008000-200-RS	Dual-channel 18-bit 30-pin to 24-bit 30-pin LVDS connection cable