

Click to
ORDER
samples

AMEM5-277HAVZ



Encapsulated

AMEM5-277HAVZ series is an efficient 5W AC-DC power supply module. Offering a commercial input voltage range of 85-305VAC, output voltage ranges from 3.3-24V, low power consumption, high efficiency, high reliability, and safer isolation.

This new series offers great operating temperatures, from -40°C to 85°C with full power up to 50°C and features an isolation of 4000VAC for improved reliability and system safety. Furthermore, a higher MTBF of 2602,000h, output short circuit protection (OSCP), output over-current protection (OCP) and an output over-voltage protection (OVP) come standard with the series.

The AMEM5-277HAVZ is perfect for grid power, LED, instrumentation, industrial controls, communication, and civil applications.

Features

- Universal Input: 85 - 305VAC/100 - 430VDC
- Operating Temp: -40 °C to +85 °C
- High isolation voltage: 4000VAC
- Low ripple & noise, 100mV(p-p), max.
- Output short circuit, over-current, over-voltage protection
- Low no-load power consumption of 0.1W
- Efficiency up to 81.5%

Summary

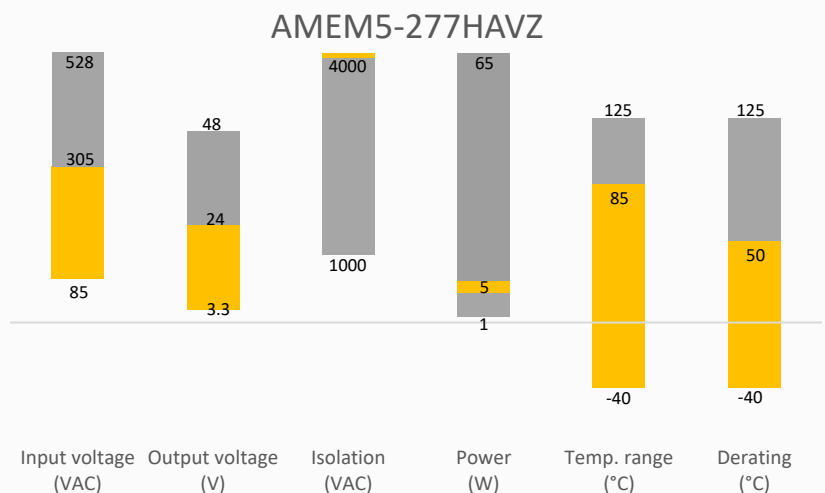

Training

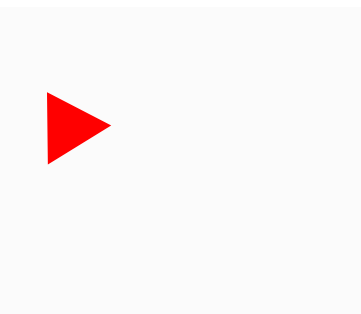

Product Training Video
(click to open)

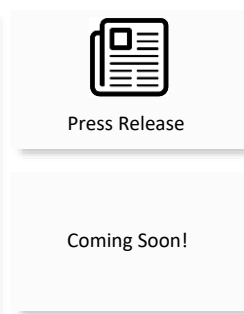

Application Notes

Applications



Power Grid



Industrial



Telecom



Instrumentation

Models & Specifications

Single Output							
Model	Input Voltage (VAC/Hz)	Input Voltage (VDC)	Max Output wattage (W)	Output Voltage (V)	Output Current max (A)	Maximum capacitive load (μ F)	Efficiency @ 230VAC Typ. (%)
AMEM5-3S277HAVZ	85-305/47-63	100-430	5	3.3	1.515	4000	71.5
AMEM5-5S277HAVZ	85-305/47-63	100-430	5	5	1	3000	77.5
AMEM5-9S277HAVZ	85-305/47-63	100-430	5	9	0.555	1200	80.5
AMEM5-12S277HAVZ	85-305/47-63	100-430	5	12	0.416	1200	80.5
AMEM5-15S277HAVZ	85-305/47-63	100-430	5	15	0.333	680	81.5
AMEM5-24S277HAVZ	85-305/47-63	100-430	5	24	0.208	220	81.5

Note: Use suffix "ST" for chassis and suffix "STD" for DIN-Rail mounting (ex. AMEM5-3S277HAVZ-ST is chassis mounting and AMEM5-3S277HAVZ-STD is DIN-Rail mounting version).

Input Specifications				
Parameters	Conditions	Typical	Maximum	Units
Input current	115VAC		130	mA
	230VAC		70	mA
Inrush current	115VAC	15		A
	230VAC	25		A
Leakage	277VAC, 50Hz		0.25	mA RMS
Fuse	1A, Slow blow			

Output Specifications				
Parameters	Conditions	Typical	Maximum	Units
Voltage accuracy	3.3Vout	± 3		%
	Others	± 2		%
Line regulation	Full load	± 0.5		%
Load regulation	0-100% load	± 1		%
Ripple & Noise*	20MHz bandwidth	50	100	mV p-p
Hold up time	115VAC	5		ms
	230VAC	50		ms

* Ripple and Noise are measured at 20MHz bandwidth with a 10 μ F electrolytic capacitor and a 1 μ F ceramic capacitor. Please refer to the application note for specific details.

Isolation Specification				
Parameters	Conditions	Typical	Maximum	Units
Tested I/O voltage	60 sec, leakage \leq 5mA	4000		VAC

General Specifications				
Parameters	Conditions	Typical	Maximum	Units
Protection class	Class II			
Over current protection	Auto recovery	≥ 130		% of Iout
Over voltage protection	3.3, 5Vout, voltage clamp, hiccup		7.5	VDC
	9Vout, voltage clamp, hiccup		15	VDC
	12Vout, voltage clamp, hiccup		16	VDC
	15Vout, voltage clamp, hiccup		20	VDC
	24Vout, voltage clamp, hiccup		30	VDC
Short circuit protection	Hiccup, Continuous, Auto recovery			
Switching Frequency		65		KHz
Operating altitude			5000	m
Operating temperature	See derating graph	-40 to +85		°C
Storage temperature		-40 to +105		°C
Reflow soldering temperature	Duration 5 - 10s	260		°C
Manual soldering temperature	Duration 3 - 5s	360		°C
No-load power consumption	230VAC	0.1		W
Power Derating	-40 °C to -25 °C	3.0		%/°C
	+50 °C to +70 °C, 3.3Vout	1.75		%/°C
	+55 °C to +70 °C, 5/9/12Vout	2.33		%/°C
	+60 °C to +70 °C, 15/24Vout	3.5		%/°C
	+70 °C to +85 °C, 3.3Vout	1.67		%/°C
	+70 °C to +85 °C, 5/9/12/15/24Vout	1.0		%/°C
	85VAC to 100VAC	1.0		%/VAC
	277VAC to 305VAC	0.54		%/VAC
	2000m - 5000m	0.67		%/km
Temperature coefficient		±0.02		%/°C
Cooling	Free air convection			
Humidity	Non-condensing		95	% RH
Case material	Plastic (flammability to UL 94V-0)			
Weight	PCB mountable models, 15, 24Vout	18.5		g
	PCB mountable models, others	18		g
	With optional -ST mounting plate	38		g
	With optional -STD mounting plate	58		g
Dimensions (L x W x H)	PCB mountable models	1.00 x 1.00 x 0.69 inches (25.40 x 25.40 x 17.60 mm)		
	With optional -ST mounting plate	2.99 x 1.24 x 1.04 inches (76.00 x 31.50 x 26.40 mm)		
	With optional -STD mounting plate	2.99 x 1.24 x 1.22 inches (76.00 x 31.50 x 31.00 mm)		
MTBF	> 2 602 000 hrs (MIL-HDBK -217F, t=+25°C)			
NOTE: All specifications in this datasheet are measured at an ambient temperature of 25°C, humidity<75%, nominal input voltage and at rated output load unless otherwise specified.				

Safety Specifications		
Parameters		
Agency Approval	cULus	UL62368-1
Standards	Design to meet IEC/EN/UL 62368, EN60335, EN61558	
	EMC - Conducted and radiated emission	CISPR32 / EN55032, class B EN55014-1
	Electrostatic Discharge Immunity	IEC 61000-4-2 Contact ±6KV, Air ±8KV, Criteria B EN55014-2, Criteria B
	RF, Electromagnetic Field Immunity	IEC 61000-4-3 10V/m, Criteria A EN55014-2, Criteria A
	Electrical Fast Transient/Burst Immunity	IEC 61000-4-4 ±2KV, Criteria B with the typical application circuit IEC 61000-4-4 ±4KV, Criteria B with the recommended EMC circuit

	EN55014-2, Criteria B
Surge Immunity	IEC 61000-4-5 L-L ± 1 KV, Criteria B with the typical application circuit IEC 61000-4-5 L-L ± 2 KV, Criteria B with the recommended EMC circuit EN55014-2, Criteria B
RF, Conducted Disturbance Immunity	IEC 61000-4-6 10Vr.m.s, Criteria A EN55014-2, Criteria A
Voltage dips, Short Interruptions Immunity	IEC 61000-4-11 0%, 70%, Criteria B EN55014-2, Criteria B

Derating

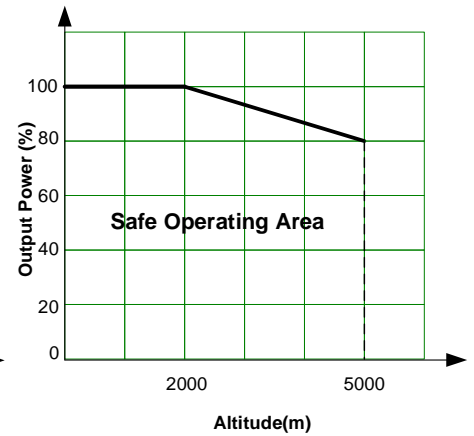
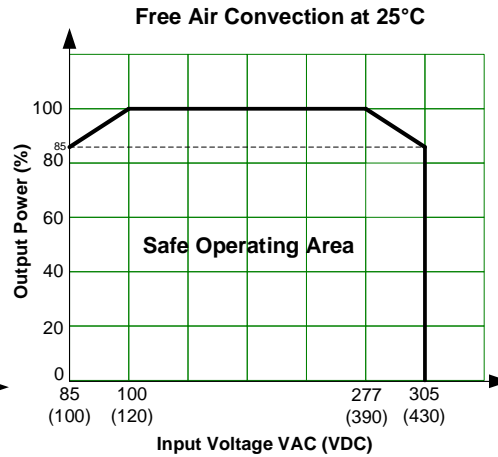
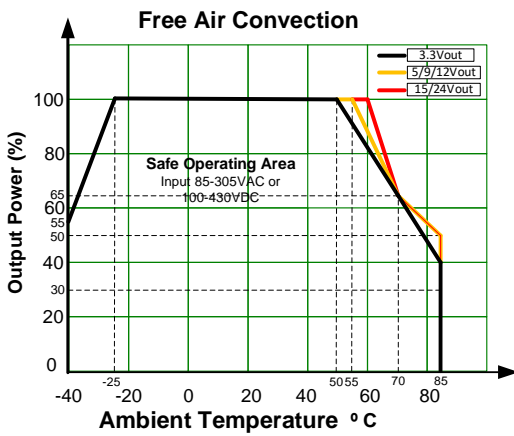

Efficiency vs input voltage



Efficiency vs input voltage (Full load)

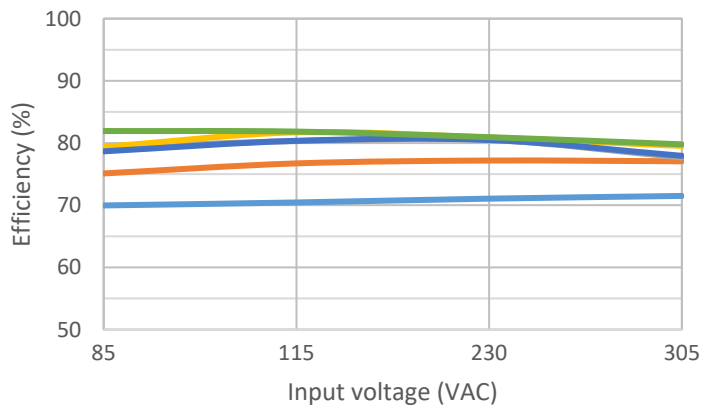

- AMEM5-3S277HAVZ — AMEM5-5S277HAVZ
- AMEM5-9S277HAVZ — AMEM5-12S277HAVZ
- AMEM5-15S277HAVZ — AMEM5-24S277HAVZ

Typical Application Circuit

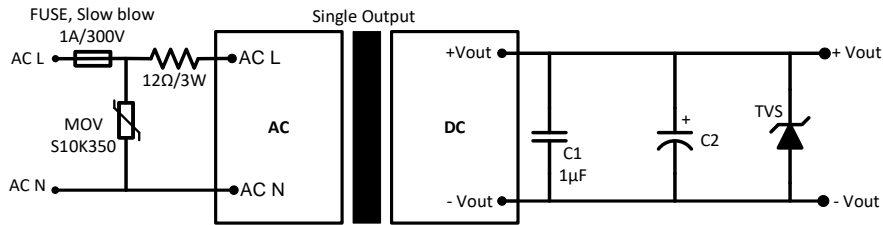

Model	C2	TVS
3.3, 5Vout	150μF	7V
9Vout	120μF	12V
12, 15Vout	120μF	20V
24Vout	68μF	30V

For filtering components:

The input fuse is recommended to use slow blow type. Choose capacitors with at least 20% voltage margin. The C2 capacitor is recommended to use electrolytic type with high frequency and low ESR rating. The C1 capacitor is recommended to use ceramic type for filtering high-frequency noise.

Recommended EMC Circuit

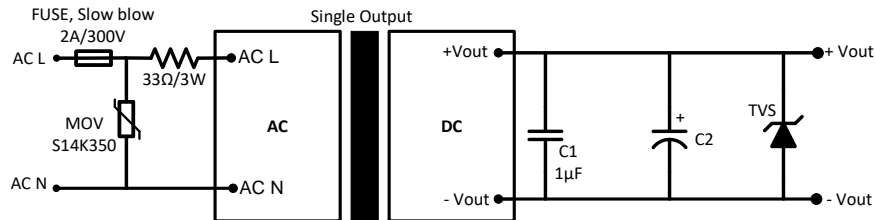

Dimensions

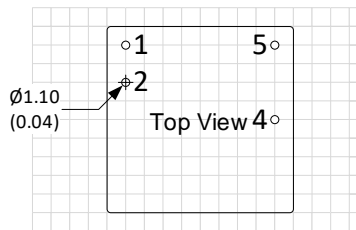
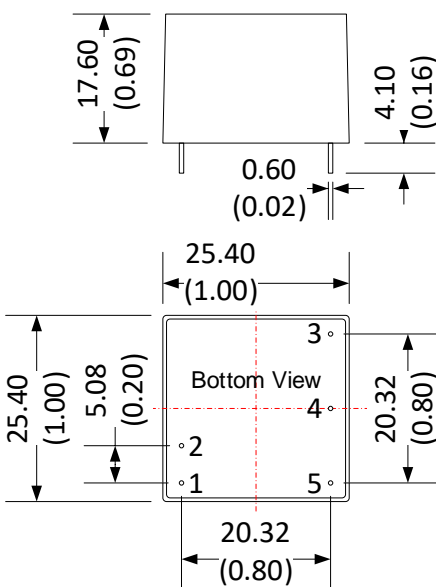

Grid size: 2.54*2.54mm

Pin Output Specifications	
Pin	Function
1	AC Input (N)
2	AC Input (L)
3	No Pin
4	-V Output
5	+V Output

Note:

Unit: mm(inch)

General tolerance: ± 0.5 (± 0.02)

Pin diameter tolerance: ± 0.1 (± 0.004)

Dimensions with ST Optional

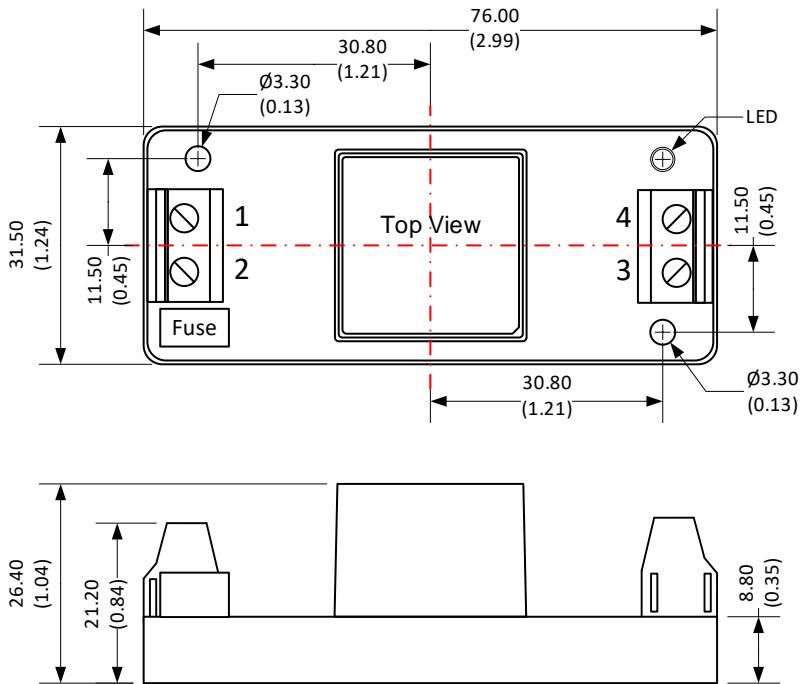

Pin Output Specifications	
Pin	Function
1	AC Input (N)
2	AC Input (L)
3	-V Output
4	+V Output

Note:

Unit: mm(inch)

Wire range : 24-12 AWG

Tightening torque : Max 0.4 N.m

General tolerance ± 1.00 : (± 0.04)

Dimensions with STD Optional

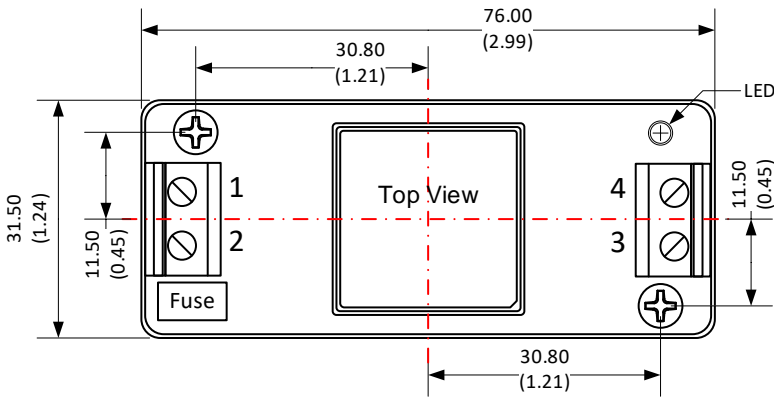

Pin Output Specifications	
Pin	Function
1	AC Input (N)
2	AC Input (L)
3	-V Output
4	+V Output

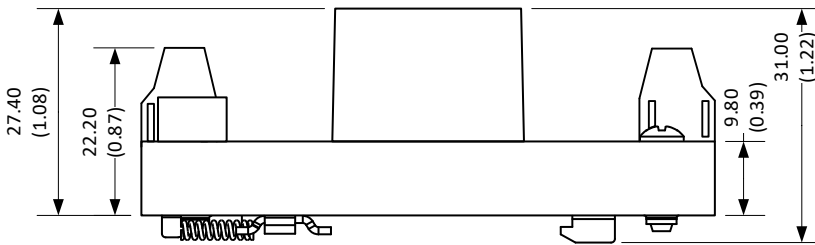

Note:

Unit: mm(inch)

Wire range : 24-12 AWG

Mounting rail: TS35

Tightening torque : Max 0.4 N.m

General tolerance ± 1.00 : (± 0.04)

Mounting rail must be grounded.

NOTE: 1. Datasheets are updated as needed and as such, specifications are subject to change without notice. Once printed or downloaded, datasheets are no longer controlled by Aimtec; refer to www.aimtec.com for the most current product specifications. 2. Product labels shown, including safety agency certifications on labels, may vary based on the date manufactured. 3. Mechanical drawings and specifications are for reference only. 4. All specifications are measured at an ambient temperature of 25°C, humidity<75%, nominal input voltage and at rated output load unless otherwise specified. 5. Aimtec may not have conducted destructive testing or chemical analysis on all internal components and chemicals at the time of publishing this document. CAS numbers and other limited information are considered proprietary and may not be available for release. 6. This product is not designed for use in critical life support systems, equipment used in hazardous environments, nuclear control systems or other such applications which necessitate specific safety and regulatory standards other the ones listed in this datasheet. 7. Warranty is in accordance with Aimtec's standard Terms of Sale available at www.aimtec.com.