

Click to  
**ORDER**  
samples

AM1SS-LPZ



SIP4 Package

The AM1SS-LPZ is a 1W SIP4 DC/DC converter that offers great cost savings thanks to an improved manufacturing process. It also features excellent reliability and performance while offering a standard input voltage range of 3.3-24VDC as well as an output voltage of 3.3-24V. This compact SIP4 design will surely benefit your new system design.

This new series offers great operating temperatures, from -40 to 105°C with full power up to 85°C. Also, an isolation of 1500VDC for improved reliability and system safety as well as a great 3,500,000h MTBF come standard.

The AM1SS-LPZ is suitable for instrumentation, industrial controls, industrial applications, communication and IoT applications.

Features

- High I/O Isolation of 1500VDC
- Continuous Short circuit protection
- Operating Temp: -40 °C to +105 °C
- Industry standard SIP4 pin-out
- Efficiency up to 92%
- Unregulated output

Summary

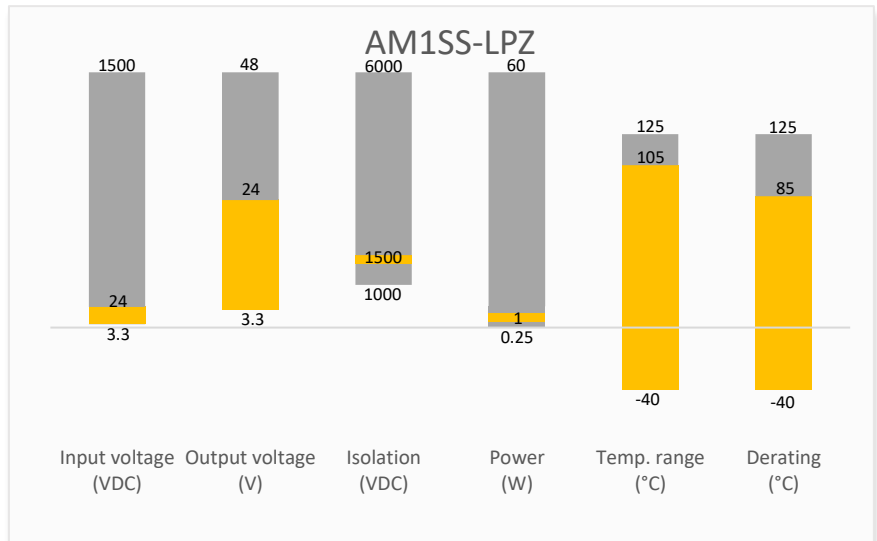

Training



Product Training Video  
(click to open)



Press Release

Coming Soon!

Application Notes

Applications



IoT



Industrial



Telecom



Portable Equipment

## Models & Specifications



### Single Output

Model	Input Voltage (VDC)	Output Voltage (VDC)	Output Current max   min (mA)*	Isolation (VDC)	Maximum capacitive Load (μF)	Efficiency Typ. (%)
AM1SS-0303SLPZ	3.3 (2.97-3.63)	3.3	303 / 30	1500	4000	82
AM1SS-0305SLPZ	3.3 (2.97-3.63)	5	200 / 20	1500	4000	83
AM1SS-0309SLPZ	3.3 (2.97-3.63)	9	111 / 11	1500	2000	84
AM1SS-0312SLPZ	3.3 (2.97-3.63)	12	84 / 8	1500	1000	85
AM1SS-0503SLPZ	5 (4.5-5.5)	3.3	303 / 30	1500	4000	80
AM1SS-0505SLPZ	5 (4.5-5.5)	5	200 / 20	1500	4000	87
AM1SS-0509SLPZ	5 (4.5-5.5)	9	111 / 12	1500	2000	86
AM1SS-0512SLPZ	5 (4.5-5.5)	12	84 / 9	1500	1000	88
AM1SS-0515SLPZ	5 (4.5-5.5)	15	67 / 7	1500	680	88
AM1SS-0524SLPZ	5 (4.5-5.5)	24	42 / 4	1500	560	89
AM1SS-1203SLPZ	12 (10.8-13.2)	3.3	303 / 30	1500	4000	84
AM1SS-1205SLPZ	12 (10.8-13.2)	5	200 / 20	1500	4000	88
AM1SS-1209SLPZ	12 (10.8-13.2)	9	111 / 12	1500	2000	87
AM1SS-1212SLPZ	12 (10.8-13.2)	12	84 / 9	1500	1000	90
AM1SS-1215SLPZ	12 (10.8-13.2)	15	67 / 7	1500	680	88
AM1SS-1224SLPZ	12 (10.8-13.2)	24	42 / 5	1500	560	89
AM1SS-1503SLPZ	15 (13.5-16.5)	3.3	200 / 20	1500	4000	85
AM1SS-1505SLPZ	15 (13.5-16.5)	5	200 / 20	1500	4000	85
AM1SS-1509SLPZ	15 (13.5-16.5)	9	111 / 12	1500	2000	91
AM1SS-1512SLPZ	15 (13.5-16.5)	12	84 / 9	1500	1000	89
AM1SS-1515SLPZ	15 (13.5-16.5)	15	67 / 7	1500	680	89
AM1SS-2403SLPZ	24 (21.6-26.4)	3.3	303 / 30	1500	4000	84
AM1SS-2405SLPZ	24 (21.6-26.4)	5	200 / 20	1500	4000	87
AM1SS-2409SLPZ	24 (21.6-26.4)	9	111 / 12	1500	2000	92
AM1SS-2412SLPZ	24 (21.6-26.4)	12	84 / 9	1500	1000	88
AM1SS-2415SLPZ	24 (21.6-26.4)	15	67 / 7	1500	680	88
AM1SS-2424SLPZ	24 (21.6-26.4)	24	42 / 5	1500	560	89

\* Performance will be degraded if the load is not within the output current range.

### Input Specification

Parameters	Conditions	Typical	Maximum	Units
Input current	Full load, 3.3Vin	370	390	mA
	Full load, 5Vin	230	260	mA
	Full load, 12Vin	99	105	mA
	Full load, 15Vin	78	85	mA
	Full load, 24Vin	50	55	mA
No load input current		3	15	mA
Filter	Capacitor			
Absolute maximum rating	Maximum duration 1s, 3.3Vin	> -0.7	5	VDC
	Maximum duration 1s, 5Vin	> -0.7	9	VDC
	Maximum duration 1s, 12Vin	> -0.7	18	VDC
	Maximum duration 1s, 15Vin	> -0.7	21	VDC
	Maximum duration 1s, 24Vin	> -0.7	30	VDC

Input reflected ripple current		15		mA
--------------------------------	--	----	--	----

Isolation Specification				
Parameters	Conditions	Typical	Maximum	Units
Tested I/O voltage	60 sec, leakage $\leq$ 1mA	>1500		VDC
Resistance	500VDC	>1000		M $\Omega$
Capacitance	100kHz/0.1V	20		pF

Output Specification				
Parameters	Conditions	Typical	Maximum	Units
Voltage accuracy	See output voltage tolerance		10	%
Line regulation	Per 1% Vin change, 3.3Vout models		1.5	%
	Per 1% Vin change, other models		1.2	%
Load regulation	10-100% load, 3.3Vout	10		%
	10-100% load, 5Vout	8		%
	10-100% load, 9Vout	8		%
	10-100% load, 12Vout	7		%
	10-100% load, 15Vout	6		%
	10-100% load, 24Vout	6		%
Ripple & Noise*		45	70	mV pk-pk
Temperature coefficient		$\pm$ 0.03		%/°C

\* Ripple and Noise are measured at 20MHz bandwidth. Please refer to the application note for specific details.

General Specifications				
Parameters	Conditions	Typical	Maximum	Units
Switching frequency	Full load	220		KHz
Short circuit protection	Continuous, Auto recovery			
Operating temperature	With derating	-40 to +105		°C
Storage temperature		-55 to +125		°C
Case temperature rise	Full load	15		°C
Manual soldering temperature	1.5mm away from case, duration $\leq$ 10sec		300	°C
Cooling	Free air convection			
Humidity	Non-condensing	>5	95	% RH
Vibration	10-150Hz, 5G, 0.75mm, along X, Y and Z			
Case material	Black plastic (flammability to UL 94V-0)			
Weight		1.6		g
Dimensions (L x W x H)	0.46 x 0.24 x 0.40 inches (11.60 x 6.00 x 10.20 mm)			
MTBF	3 500 000 hrs (MIL-HDBK -217F, t=+25°C) / Full Load			

NOTE: All specifications in this datasheet are measured at an ambient temperature of 25°C, humidity<75%, nominal input voltage and at rated output load unless otherwise specified.

Safety Specifications		
Parameters		
Standards	Information technology Equipment	Design to meet UL/EN/IEC 62368-1
	EMC - Conducted and radiated emission	CISPR32 / EN55032, class B with the recommended EMI circuit
	Electrostatic Discharge Immunity	IEC 61000-4-2

Derating

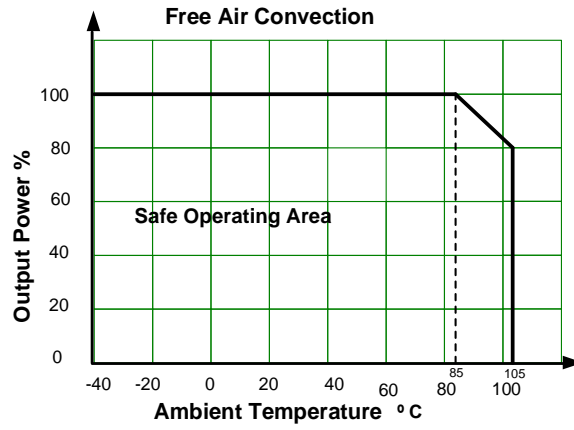

Output voltage tolerance



Tolerance Envelope Graph

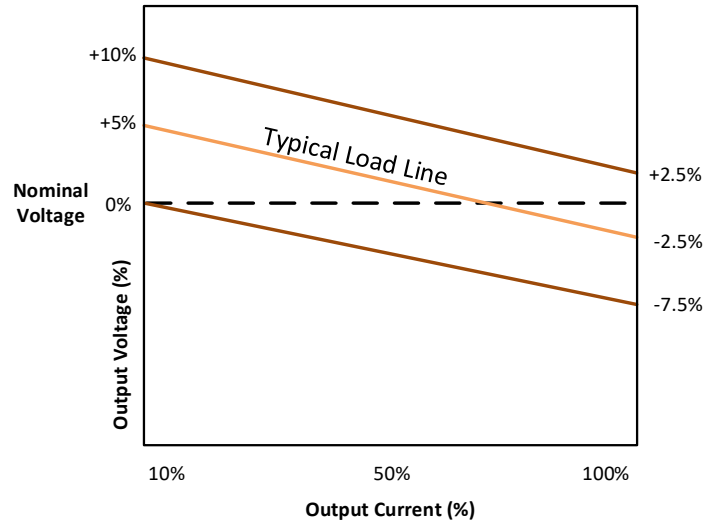

Typical application circuit

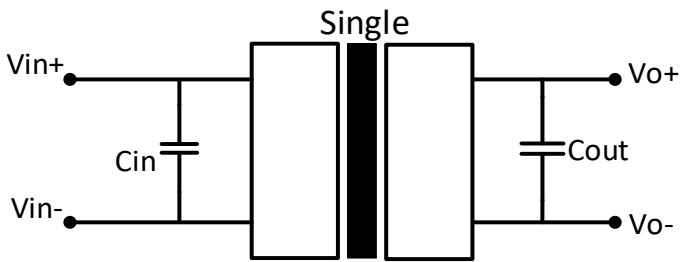

Vin	Cin
3.3V	4.7μF/16V
5V	4.7μF/16V
12	2.2μF/25V
15V	2.2μF/25V
24V	1μF/50V

Vout	Cout
3.3V	10μF/16V
5V	10μF/16V
9V	4.7μF/16V
12V	2.2μF/25V
15V	1μF/25V
24V	0.47μF/50V

Recommended EMI circuit

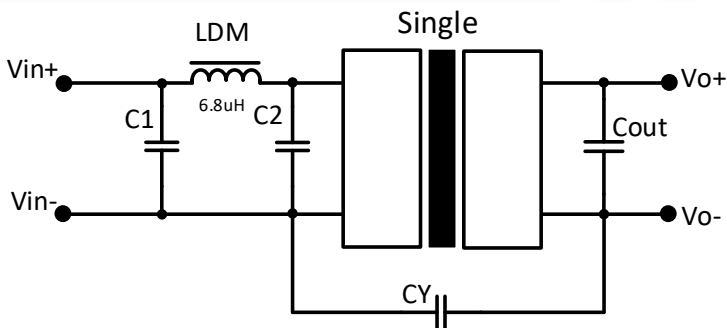

Vout	C1/C2	CY
3.3/5/9/12/15/24V	4.7μF/50V	1nF/2kVdc

## Dimensions

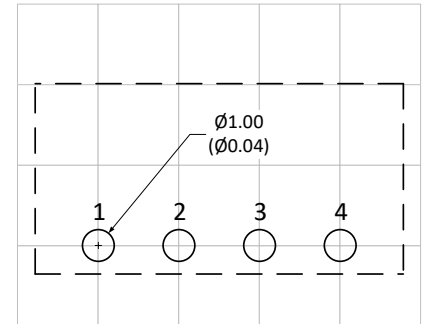
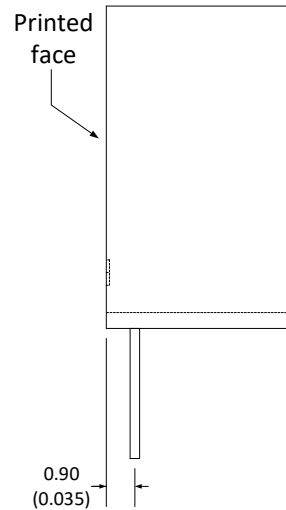
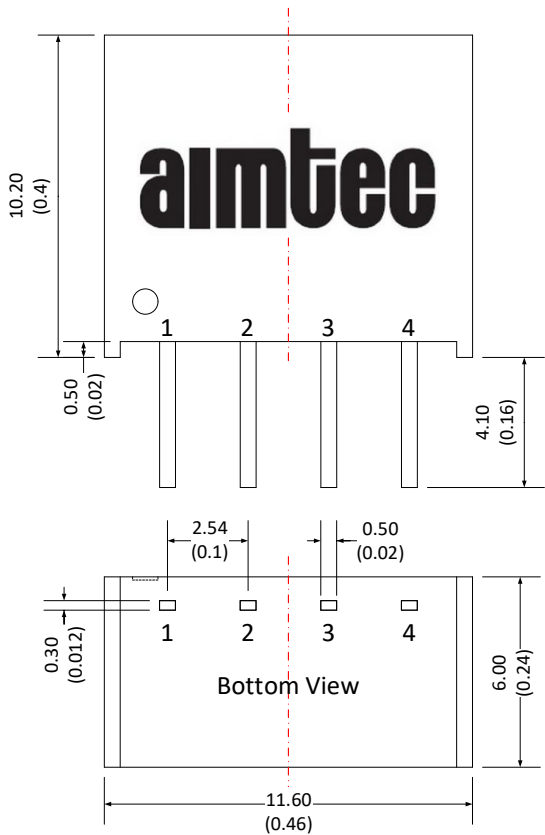

Grid size: 2.54\*2.54mm

### Note:

Unit: mm(inch)

General tolerance:  $\pm 0.50$  (0.02)

Pin tolerance:  $\pm 0.1$  (0.004)

Pin Out Specifications	
Pin	Single output
1	-V Input
2	+V Input
3	-V Output
4	+V Output

**NOTE:** 1. Datasheets are updated as needed and as such, specifications are subject to change without notice. Once printed or downloaded, datasheets are no longer controlled by Aimtec; refer to [www.aimtec.com](http://www.aimtec.com) for the most current product specifications. 2. Product labels shown, including safety agency certifications on labels, may vary based on the date manufactured. 3. Mechanical drawings and specifications are for reference only. 4. All specifications are measured at an ambient temperature of 25°C, humidity<75%, nominal input voltage and at rated output load unless otherwise specified. 5. Aimtec may not have conducted destructive testing or chemical analysis on all internal components and chemicals at the time of publishing this document. CAS numbers and other limited information are considered proprietary and may not be available for release. 6. This product is not designed for use in critical life support systems, equipment used in hazardous environments, nuclear control systems or other such applications which necessitate specific safety and regulatory standards other the ones listed in this datasheet. 7. Warranty is in accordance with Aimtec's standard Terms of Sale available at [www.aimtec.com](http://www.aimtec.com).