



**FEATURES:**

- Efficiency up to 85%
- Ultra-wide 4:1 Input range
- Continuous short circuit protection
- Operating Temperature: -40°C to +85°C
- On/Off Remote Control
- Over Voltage & Over Current Protection
- Input / Output Isolation 2250VDC
- Input Under Voltage Lockout



**Models**  
**Single output**

Model	Input Voltage (V)	Output Voltage (V)	Output Current max (mA)	Isolation (VDC)	Max Capacitive Load (uF)	Efficiency (%)
AM15EW-11003SH22-NZ	40-160	3.3	4000	2250	5400	82
AM15EW-11005SH22-NZ	40-160	5	3000	2250	5400	84
AM15EW-11012SH22-NZ	40-160	12	1250	2250	1000	84
AM15EW-11015SH22-NZ	40-160	15	1000	2250	820	85
AM15EW-11024SH22-NZ	40-160	24	625	2250	270	85

Add suffix “-K” for optional heat sink

\*Add suffix “-ST” for optional screw terminal bottom plate or “-STD” for optional DIN Rail screw terminal bottom plate and reverse voltage protection.

\*\*Add suffix “-K” for optional heatsink, “-K-ST” for optional heatsink and screw terminal bottom plate or “-K-STD” for optional heatsink and DIN Rail screw terminal bottom plate and reverse voltage protection.

NOTE: All specifications in this datasheet are measured at an ambient temperature of 25°C, humidity<75%, nominal input voltage and at rated output load unless otherwise specified.

**Input Specifications**

Parameters	Nominal	Typical	Maximum	Units
	110	40-160		VDC
Filter		π(Pi) Network		
Startup time		10		ms
	110		180	VDC
Peak Input Voltage time			1	s
On/Off control	110V input	ON – open or 3.5-12VDC; OFF – short to –Vin or 0-1.2VDC, Idle current 1mA		
No load Input Current			60	mA
Input reflected current		30		mA

**Isolation Specifications**

Parameters	Conditions	Rated	Maximum	Units
Tested I/O voltage	60 sec, 1mA	1500 & 2250		VDC
Tested I/FG & O/FG voltage	2250V Isolated models, 60 sec, 1mA	1600		VDC
Resistance		>1000		MOhm
Capacitance	110Vin 2250V Isolation, I/O, 100KHz/0.1V	2000		pF

**Output Specifications**

Parameters	Conditions	Typical	Maximum	Units
Voltage accuracy		±3		%
Over voltage protection	Zener Diode Clamp			%
Over current protection		120	210	% of Io
Short Circuit protection	Hiccup, Continuous			
Short circuit restart	Auto-Recovery			
Line voltage regulation	Full load, LL-HL	±0.5		% of Vin
Load voltage regulation	0-100% load for 2250V instead models; 5-100% load others	±1		%
Temperature coefficient			±0.03	%/°C
Ripple & Noise	20MHz Bandwidth		100	mV p-p
Voltage adjustment range			±10	%
Transient recovery time	25% load step change		500	µS
Transient recovery deviation	25% load step change	±5		%

## General Specifications

Parameters	Conditions	Typical	Maximum	Units
Switching frequency	100% load	300		KHz
Operating temperature	See derating curve	-40 to +85		°C
Storage temperature		-55 to +125		°C
Maximum case temperature			105	°C
Cooling	Free air convection			
Humidity			95	% RH
Case material	Aluminum Alloy			
Dimensions (L x W x H)	PCB mountable without heatsink	2.00 x 1.00 x 0.46 inches; 50.80 x 25.40 x 11.80mm		
	Optional packages	See dimensions drawing		
Weight	Pin mountable without heatsink	26 (2250VDC Isolated models)		g
	Pin mountable with heatsink	34 (2250VDC Isolated models)		
	-ST option without heatsink	48 (2250VDC Isolated models)		
	-ST option with heatsink	56 (2250VDC Isolated models)		
	-STD option without heatsink	68 (2250VDC Isolated models)		
	-STD option with heatsink	76 (2250VDC Isolated models)		
MTBF	>1,000,000 hours (MIL-HDBK -217F, Ground Benign, t=+25°C)			
Maximum soldering temperature	1.5mm from case for 10 sec		300	°C

## Environmental Specifications

### Parameters

Vibration (110 Vin/2250VDC isolation)	IEC61373 car body 1 B mold
---------------------------------------	----------------------------

## Safety Specifications

### Parameters

Approvals	CE, UL (110V input 12V, 24V output models only)
Standards	EN 55022, class B (with the recommended EMC circuit)
	IEC61000-4-2, Contact ±6KV (110Vin 2250V Isolation), Criteria B
	IEC61000-4-3, 10V/m, Criteria A
	IEC61000-4-4, ±4KV (110Vin 2250V Isolation), Criteria B
	IEC61000-4-5, ±2KV, Criteria B, (with the recommended EMC circuit)
	IEC61000-4-6, 10 Vrms (2250 VDC Isolated models) Criteria A
	Design to meet IEC/EN/UL 60950-1, EN50155
IEC/EN/UL 62368 approved (AM15EW-11012SH22-NZ & AM15EW-11024SH22-NZ models only)	

## Pin Out Specifications

Pin	Single
1	On/Off Control
2	-Vin
3	+Vin
4	-Vout
5	Trim
6	+Vout

## Dimensions

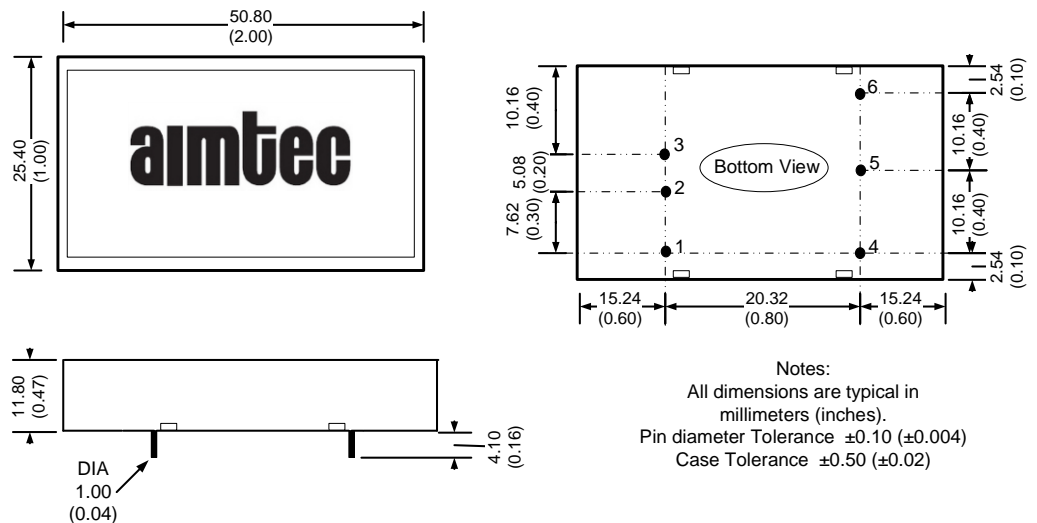

**Optional -K heatsink**

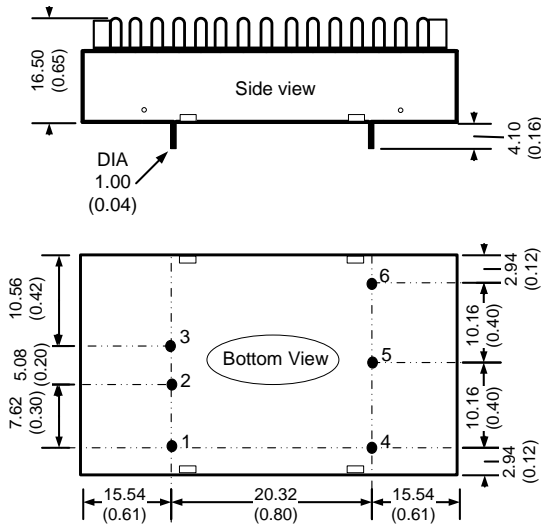

Notes:  
All dimensions are typical in millimeters (inches).  
Pin diameter Tolerance:  $\pm 0.10$  ( $\pm 0.004$ )  
Case Tolerance:  $\pm 0.50$  ( $\pm 0.02$ )

**Pin Out Specifications**

Pin	Single
1	On/Off Control
2	-Vin
3	+Vin
4	-Vout
5	Trim
6	+Vout

**Dimensions with -ST options**

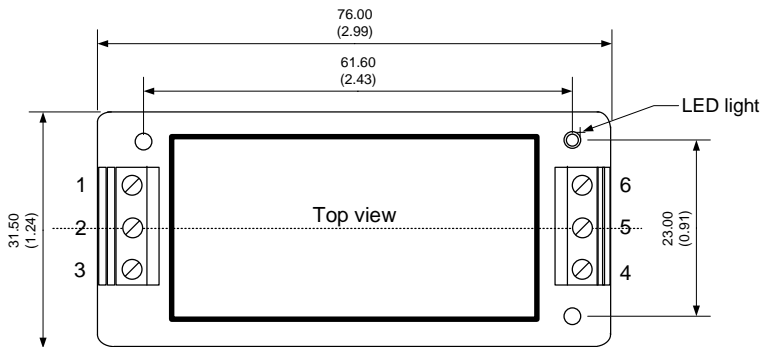

Dimensions: mm (inch)  
Case Tolerance:  $\pm 0.50$  (0.02)  
Wire gauge: 24-12AWG

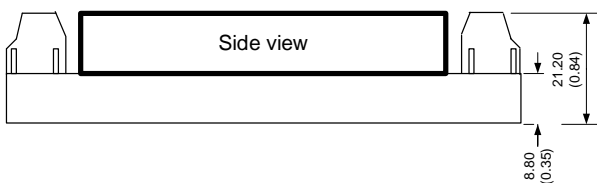

**Pin Out Specifications**

Pin	Single
1	On/Off Control
2	-Vin
3	+Vin
4	+ Vout
5	Trim
6	- Vout

**Dimensions with -STD options**

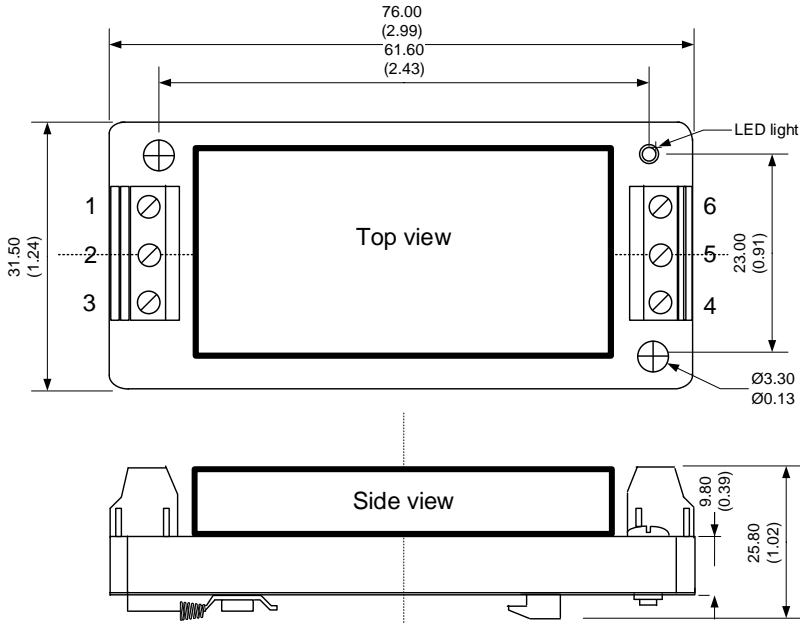

Dimensions: mm (inch)  
Case Tolerance: ± 1.00 (0.04)  
Wire gauge: 24-12AWG

**Pin Out Specifications**

Pin	Single
1	On/Off Control
2	-Vin
3	+Vin
4	+ Vout
5	Trim
6	- Vout

**Dimensions with heatsink and -ST options**

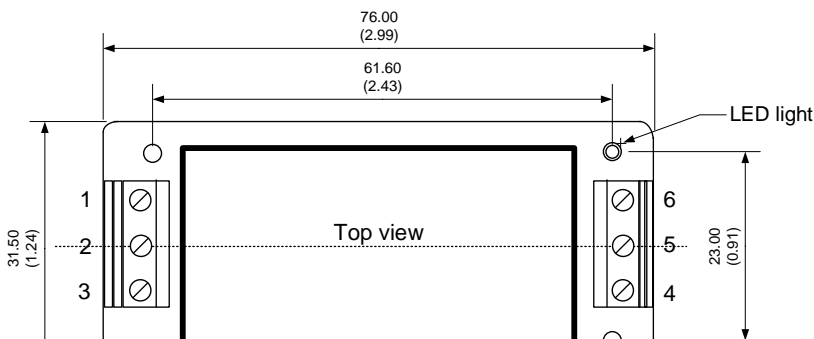

**Pin Out Specifications**

Pin	Single
1	On/Off Control
2	-Vin
3	+Vin
4	+ Vout
5	Trim
6	- Vout

### Dimensions with heatsink and -STD options

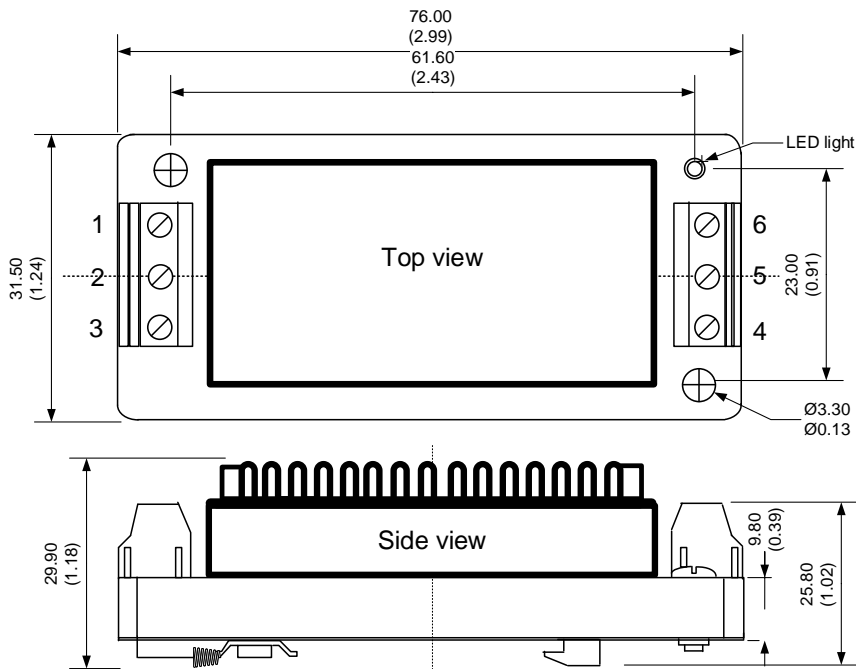

Dimensions: mm (inch)  
Case Tolerance:  $\pm 0.50$  (0.02)  
Wire gauge: 24-12AWG

### Pin Out Specifications

Pin	Single
1	On/Off Control
2	-Vin
3	+Vin
4	+ Vout
5	Trim
6	- Vout

### Trimming

Output voltage can be externally trimmed by utilizing the methods as shown below

**Fixed Resistor**      **Variable Potentiometer**

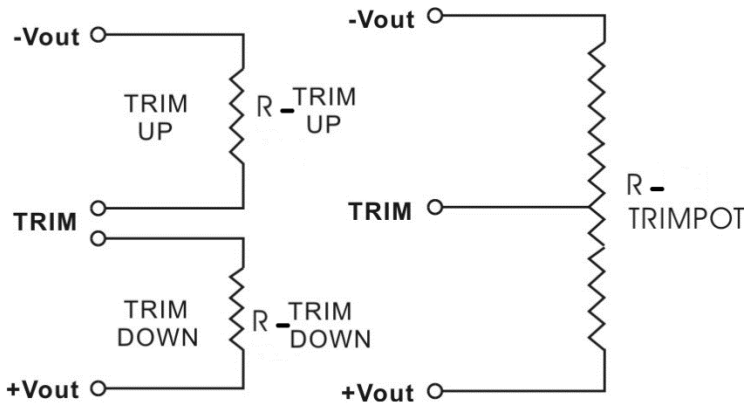

Leave open if not used.

AM15EW-11003SH22-NZ

Trim down %	1	2	3	4	5	6	7	8	9	10
Vout (VDC)	3.267	3.234	3.201	3.168	3.135	3.102	3.069	3.036	3.003	2.970
Rt down (KΩ)	210.00	103.33	72.327	54.213	42.335	31.667	25.963	21.505	16.884	14.124
Trim up %	1	2	3	4	5	6	7	8	9	10
Vout (VDC)	3.333	3.366	3.399	3.432	3.465	3.498	3.531	3.564	3.597	3.63
Rt up (KΩ)	369.17	96.88	59.466	41.454	28.235	22.058	17.6	14.23	10.837	8.857

AM15EW-11005SH22-NZ

Trim down %	1	2	3	4	5	6	7	8	9	10
Vout (VDC)	4.95	4.9	4.85	4.8	4.75	4.7	4.65	4.6	4.55	4.5
Rt down (KΩ)	105.18	52.154	31.997	21.378	14.823	10.373	7.155	4.719	2.811	1.277
Trim up %	1	2	3	4	5	6	7	8	9	10
Vout (VDC)	5.05	5.1	5.15	5.2	5.25	5.3	5.35	5.4	5.45	5.5
Rt up (KΩ)	176.35	71.279	41.974	28.2	20.198	14.967	11.281	8.544	6.430	4.749

AM15EW-11012SH22-NZ

Trim down %	1	2	3	4	5	6	7	8	9	10
Vout (VDC)	11.88	11.76	11.64	11.52	11.4	11.28	11.16	11.04	10.92	10.8
Rt down (KΩ)	496.09	301.45	212.52	161.585	128.57	105.44	88.332	75.164	64.716	56.22
Trim up %	1	2	3	4	5	6	7	8	9	10
Vout (VDC)	12.12	12.24	12.36	12.48	12.6	12.72	12.84	12.96	13.08	13.2
Rt up (KΩ)	706.43	158.92	83.879	54.075	38.077	28.095	21.274	16.317	12.552	9.595

AM15EW-11015SH22-NZ

Trim down %	1	2	3	4	5	6	7	8	9	10
Vout (VDC)	14.85	14.7	14.55	14.4	14.25	14.1	13.95	13.8	13.65	13.5
Rt down (KΩ)	974.008	517.391	346.387	256.863	201.789	164.487	137.551	117.187	101.251	88.44
Trim up %	1	2	3	4	5	6	7	8	9	10
Vout (VDC)	15.15	15.3	15.45	15.6	15.75	15.9	16.05	16.2	16.35	16.5
Rt up (KΩ)	283.713	117.996	70.541	48.045	34.918	26.315	20.242	15.725	12.235	9.45

**AM15EW-11024SH22-NZ**

Trim down %	1	2	3	4	5	6	7	8	9	10
Vout (VDC)	23.76	23.52	23.28	23.04	22.8	22.56	22.32	22.08	21.84	21.6
Rt down (KΩ)	1286.2	792.123	565.867	436.104	351.954	292.963	249.316	215.714	189.047	167.3
Trim up %	1	2	3	4	5	6	7	8	9	10
Vout (VDC)	24.24	24.48	24.72	24.96	25.2	25.44	25.68	25.92	26.16	26.4
Rt up (KΩ)	816.889	179.914	94.338	60.464	42.307	30.988	23.257	17.64	13.376	10.027

**Derating**

**110Vin 2250V Isolation**

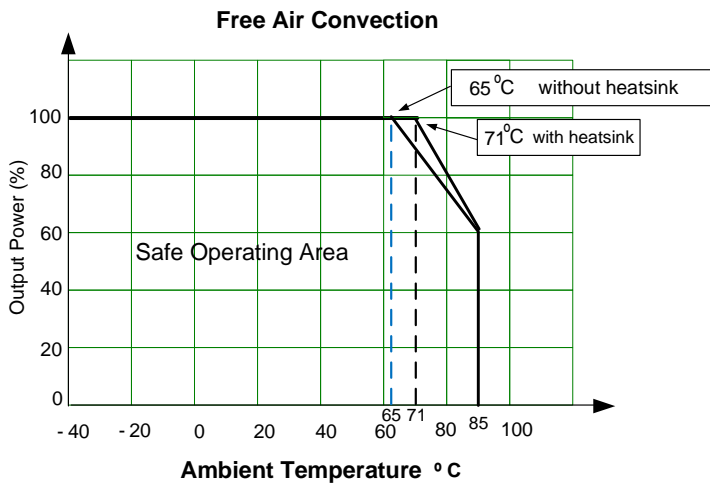

**EMC recommended filter 110Vin 2250V Isolation**



CY3 & CY4	C4	Vout	C5
1nF / 400V	10-47 $\mu$ F / 250V	3.3V & 5V	470 $\mu$ F
		12V & 15V	220 $\mu$ F
		24V	100 $\mu$ F

**NOTE:** **1.** Datasheets are updated as needed and as such, specifications are subject to change without notice. Once printed or downloaded, datasheets are no longer controlled by Aimtec; refer to [www.aimtec.com](http://www.aimtec.com) for the most current product specifications. **2.** Product labels shown, including safety agency certifications on labels, may vary based on the date manufactured. **3.** Mechanical drawings and specifications are for reference only. **4.** All specifications are measured at an ambient temperature of 25°C, humidity<75%, nominal input voltage and at rated output load unless otherwise specified. **5.** Aimtec may not have conducted destructive testing or chemical analysis on all internal components and chemicals at the time of publishing this document. CAS numbers and other limited information are considered proprietary and may not be available for release. **6.** This product is not designed for use in critical life support systems, equipment used in hazardous environments, nuclear control systems or other such applications which necessitate specific safety and regulatory standards other the ones listed in this datasheet. **7.** Warranty is in accordance with Aimtec's standard Terms of Sale available at [www.aimtec.com](http://www.aimtec.com).