

REV LTR	DATE	REV. DIMENSION	DESIGN	APPROVE
1				
2				

TZYR HWEY
 Part NO: 212-06NB0B0201
 6-PIN FFC-FPC Connector
 or EQUIVALENT
 Bottom Side Conduction

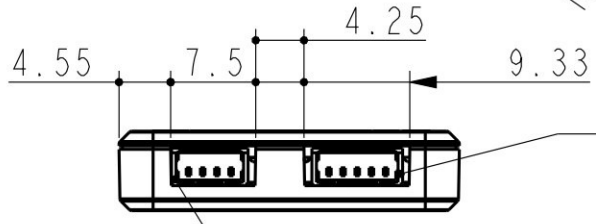

Paint Color
 PANTONE CoolGary 5C

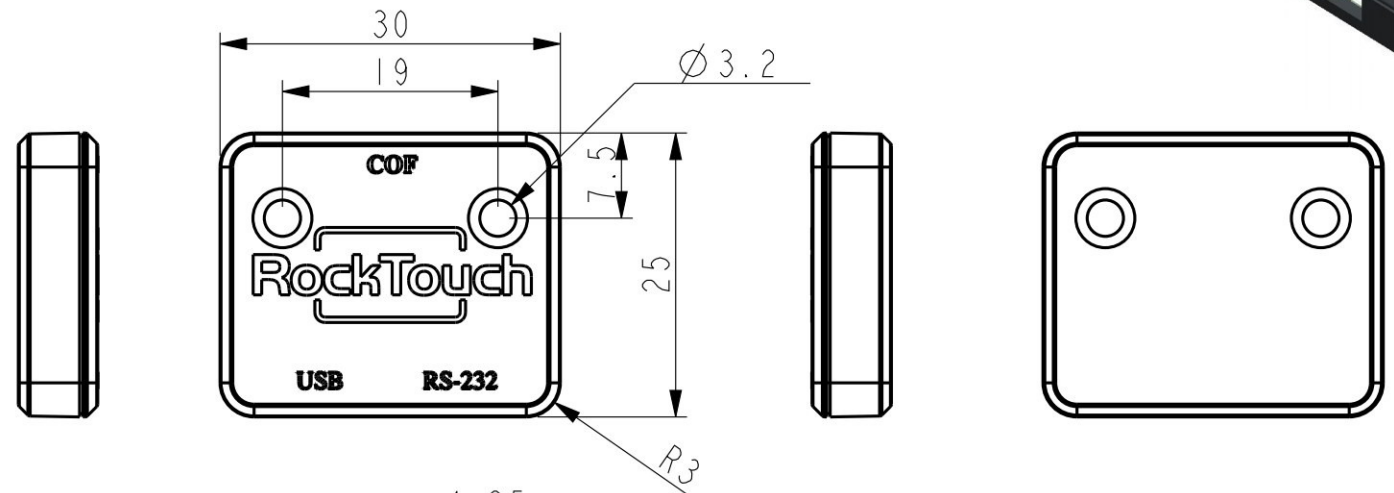

STM
 Part NO: MS24015R
 5-PIN RS-232 Connector
 or EQUIVALENT

STM
 Part NO: MS24014R
 4-PIN USB Connector
 or EQUIVALENT

TABLE (1)		ROCKTOUCH ENTERPRISE CO., LTD			TITLE: ROCKTOUCH	
RANGE	TOLERANCE	APPROVED	CHECKED	DESIGNED	FINISHED:	
201 ABOVE	± 0.3				MAT.:	
101 - 200	± 0.25				NAME: ADAPTER BOX	
51 - 100	± 0.2				PART No: ADBOXSU6P-2	
31 - 50	± 0.15				QTY: 1	SIZE: A4
30 BELOW	± 0.1 MIN				SCALE: 1/1	UNIT: MM

APPROVED: Kevin
 CHECKED: Vic
 DESIGNED: 19-Oct-15
 07-Oct-15

DWG NO: ADBOXSU6P-2 V1

CN1
FPC/6P/1.0/UPPER
P/N: 212-06NB0B0201
or Equivalent

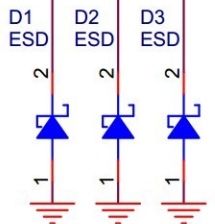
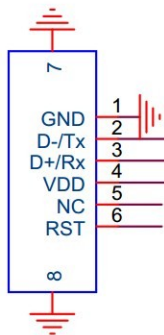

CN2 4 pin USB connector P/N: MS24014R or Equivalent

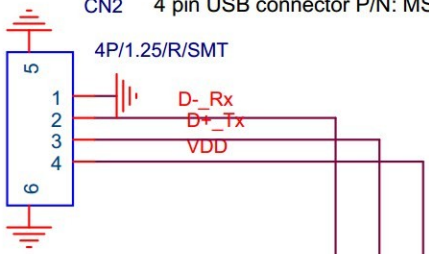

CN3
5P/1.25/R/SMT

5 pin RS232 connector
P/N: MS24015R
or Equivalent

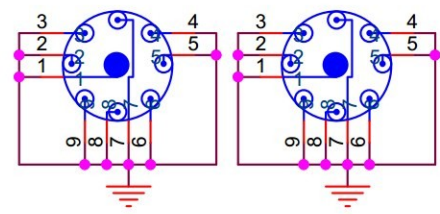
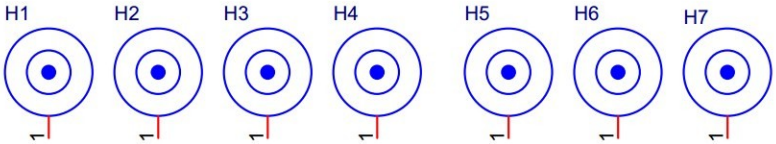
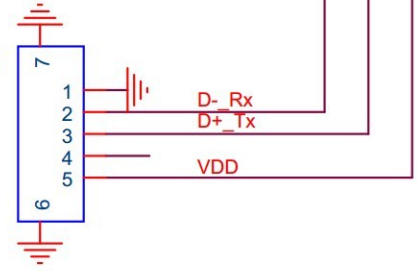

ROCKTOUCH ENTERPRISE CO., LTD		
Title PCB SCHEMATIC		
Size A	Part number : ADBOXSU6P-2	REV V1
Date: OCT.08, 2015	Sheet 1 of 1	