

1001 SERIES

I.D.C SOCKET 2.54mmX2.54mm(0.100"X0.100")

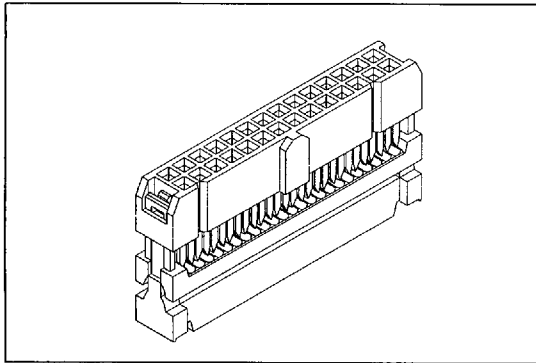

Material:

Housing: 30% Glass filled PBT UL94V-0.

Contacts: Phosphor Bronze.

Plating: Selective gold plated: gold plated on mating area and nickel plated on wire cutting area.

Gold plated: $5\mu''$ over $50\mu''$ nickel.

Cable: 1.27mm (0.050") pitch flat cable.

Electrical Characteristics:

Current Rating: 1 AMP

Insulator Resistance: 5000M Ω min. at DC 500V

Contact Resistance: 20m Ω max. at DC 100mA

Operating Temperature: $-55^{\circ}\text{C} \sim +105^{\circ}\text{C}$

Features:

- * Optional polarizing key, polarizing bump.
- * Optional strain relief.
- * Choices of gold plated or selective gold plated.

Mates with: 2011,2012,2013,3011,3012,3016,3017.

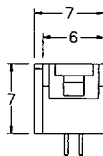
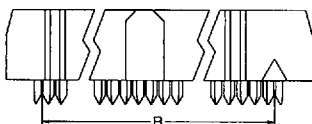
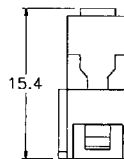
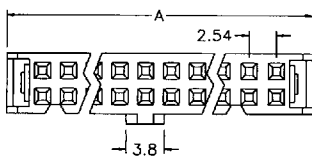
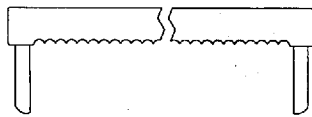
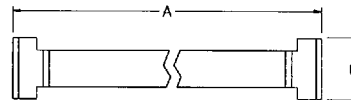
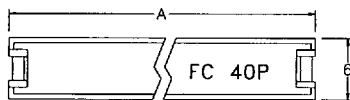

Position	Dimension	
	A	B
10	17.27	10.16
14	22.35	15.24
16	24.89	17.78
20	29.97	22.86
24	35.05	27.94
26	37.59	30.48
30	42.67	35.56
34	47.75	40.64
40	55.37	48.26
50	68.07	60.96
60	80.77	73.66
64	85.85	78.74

Ordering information

1001-10 G B 1
 Series No. of C: Selective Gold Plated B: Black 1: With Strain Relief
 Pin Count G: Gold Plated Y: Grey 2: Without Strain Relief

- * Polarizing key (1001-Key2) order separately.
- ** 1001-10GB1NB suffix NB to identify without polarizing bump.